

7.1 INTRODUCTION

Information in this section will help you to become familiar with the operation of your Sol Terminal Computer™. Following brief explanations of the operating controls and the two basic operating modes, you will put your Sol through some simple operations. This should sufficiently acquaint you with the keyboard and control switches so that you will feel at ease with your Sol. In addition, you will have performed functional tests of all Sol sections except the parallel data interface.

Detailed descriptions of the control switches are also provided to allow you to gain greater proficiency in their use. For the same reason, individual keyboard key descriptions are also given. They are intended to be used along with the BASIC/5 and SOLOS Users' Manuals (or if applicable the CONSOL description in Section IX of this manual).

The balance of this section supplies instructions for 1) connecting typical peripheral devices to the serial and parallel data interfaces (J1 and J2), 2) using audio cassette recorders, and 3) changing the fuse.

7.2 THE OPERATING CONTROLS

Sol operating controls are identified and their functions briefly defined in Table 7-1 on Page VII-2. Unless noted otherwise, the location of each control is shown on the Sol-PC assembly drawing in Section X, Page X-3.

7.3 BASIC OPERATING MODES

7.3.1 Command Mode

In this mode Sol operates as a stand alone computer under control of the program (software) contained in the personality module and additional software that is stored in the Sol, stored either in a read only memory (ROM) that is plugged into the computer or the Sol random access memory (RAM). (For a description of the CONSOL and SOLOS Personality Modules, refer to Section IX in this manual and the SOLOS Users' Manual respectively.)

With the SOLOS Personality Module installed, the computer is in the command mode when power is applied to the Sol. Command mode is a sort of "home base" from which excursions may be made into other programs. An analysis of three levels of programs will make the concept of command mode more understandable.

At the lowest level of software are the instructions which the 8080 CPU (central processing unit), the brains of the computer,

Table 7-1. Sol Operating Controls and Their Functions.

CONTROL	FUNCTION
ON-OFF Switch (See Figure 7-1)	Connects and disconnects primary power to Sol.
RST (Restart) Switch, S1-1	Permits manual restart of Sol without turning power off. (Useful for test purposes.)
BLANK Switch, S1-3	Determines if control characters are displayed or not.
POLARITY Switch, S1-4	Selects normal (white characters on black background) or reverse video display.
BLINK-SOLID Switches, S1-5 & 6	Selects blinking, nonblinking or no cursor.
SSW0 - 7 S2-1 through 8	Permits direct data entry to processor.
BAUD RATE Switches, S3-1 through 8	Sets operating speed of serial data interface (SDI).
PS & PI Switches S4-1 & 5	Selects no parity, even parity or odd parity for SDI.
WLS-1 & 2 Switches, S4-2 & 3	Selects number of data bits in transmitted word for SDI.
SBS Switch, S4-4	Determines number of stop bits in transmitted word for SDI.
F/!H Switch, S4-6	Selects half or full duplex operation for SDI.
Keyboard (See Figure 7-4)	Data entry, mode selection, command input and cursor control.

can understand and run. All programs must ultimately be reduced to this basic level to be operated on by the computer. In the case of the 8080 microprocessor, the program is in an "object code" or "machine language", since the "machine" or 8080 CPU understands it. The SOLOS program contained in the personality module is stored in this machine language form, and the computer can therefore run directly from this program. Since the SOLOS program is contained in permanent ROM which is plugged directly into the computer, the SOLOS program is always available, and is automatically selected whenever the power switch of the Sol is turned on. There is also provision for returning at all times to the command mode of SOLOS. From the command mode other programs may be brought in for various operations or stored on cassette tape. The contents of the computer's memory may be displayed or changed. The command mode also performs "housekeeping" functions such as setting the rate at which data is read from tape, or the rate at which characters are displayed on the video monitor.

The command mode allows the introduction of the second level of software. This level includes higher-level language programs such as BASIC/5 or FOCAL in which complex application programs may be more easily written. These are called higher level languages because they permit the user to write programs in a form much closer to human languages such as English. However, programs written in these languages must be translated into the more basic machine language before they can be run. Besides higher level languages, this second level of software includes programs such as the TREK 80 and GAMEPAC video games and the ALS-8 program (a software package used for developing programs), all of which are offered by Processor Technology Corporation. Through the facilities of the command mode, these second level programs are transferred (loaded) into memory from cassette tape or other storage media, and then "executed" (used). These programs may also exist in ROM or EPROM (erasable programmable ROM) memory which is plugged into the computer to make them instantly available like the SOLOS program. All first and second level programs are stored in the computer as binary object code.

Let us illustrate the concept of the second level of programs with an example, BASIC/5. Using the "XEQ" command available in the SOLOS command mode, we load the BASIC/5 program into the computer's memory from cassette tape. With this command BASIC/5 is ready for use as soon as the tape has stopped moving. The control of the computer is now taken over by the BASIC/5 program now in memory, and SOLOS is no longer in command. All the features of BASIC/5 language are now available to us, with a new set of commands and rules. Since the CPU of the computer only understands the machine language of the first level of software, the BASIC/5 program must translate the commands and data we enter to this lower level. BASIC/5 does this as we go. While we are using BASIC/5, we still have access to some of the commands and features of SOLOS, although they may have a modified form while we are in BASIC/5. We will load and use BASIC/5 later in this section.

The third level of software consists of programs written using the higher order languages of the second level programs. A program written in BASIC/5 is on this third level. This program only makes sense to the computer while the computer has BASIC/5 in memory and control has been transferred to the BASIC/5 program. Third level programs written in any high level language are often called "applications programs" since they are usually written in order to fit a specific application need.

The ALS-8 Program Development System is another second level program. A program to be developed within ALS-8 would then be a third-level application program. The ALS-8 also includes an Assembler which takes a program written on the third level in "assembly" language, and translates it to object code which the computer can run. The object code version then resides in memory and can be run in another operation. For a further discussion, of types of software see the article "Your Personal Genie" in Appendix VIII of this manual.

7.3.2 Terminal Mode

Sol operates as a CRT terminal in this mode, capable of sending keyboard data to an output port and displaying data received at the serial input port on an external video monitor via the Sol video display circuitry. When Sol is "hard-wired" to another computer or connected to a modem, the terminal mode is used for data entry, data retrieval, inquiry/response and monitoring and control applications.

Capabilities in the terminal mode depend on the personality module used. Both CONSOL and SOLOS Personality Modules permit operation as a CRT terminal. CONSOL 1) initializes Sol in the terminal mode whenever you turn the power on or initiate a system reset, 2) sends keyboard data to the serial data interface (SDI) only, and 3) provides simple stand-alone computer capabilities. SOLOS, on the other hand, 1) enters the terminal mode when given the "TERM" (terminal) command, 2) sends keyboard data to any output port available with the "SET 0" (set out) command, and 3) duplicates CONSOL functions while providing additional capabilities.

7.4 GETTING ACQUAINTED WITH Sol

One of the best ways to get acquainted with your Sol is to use it. After connecting a cassette recorder and video monitor to your Sol, you will operate the system in the terminal mode to become familiar with the keyboard and the functions of the video display switches. You will then switch to the command mode and perform some of the basic computer operations.

7.4.1 Monitor and Cassette Recorder Connections

The basic Sol system consists of the Sol, a video monitor for display (e.g., the Processor Technology PT-872 TV-Video Monitor by Panasonic) and a cassette recorder for external storage (e.g., the Panasonic Model RQ-413S).

To connect these three system components, you will need the following cables:

Audio In & Out Cables -- two cables of shielded wire fitted with miniature phone plugs at both ends.

Motor 1 Cable -- one cable pair, such as speaker wire, fitted with subminiature phone plugs at both ends. (An identical cable for Motor 2 is needed if you use two recorders.)

Video Cable -- one RG59/U coaxial cable fitted with a PL259 UHF male connector on one end and a monitor-compatible connector on the other.

Connect the basic Sol system as follows (refer to Figure 7-1 on Page VII-6):

- () Step 1. Remove top and keyboard covers from Sol.
- () Step 2. Plug one end of Audio In Cable into Audio IN jack (J7) on Sol rear panel, and plug other end into MONITOR or EARPHONE jack on recorder.
- () Step 3. Plug one end of Audio Out Cable into Audio OUT jack (J6) on Sol rear panel, and plug other end into AUXILIARY or MICROPHONE jack on recorder. (The AUXILIARY input is preferred and recommended over the MICROPHONE input.)

NOTE

If your recorder has only a microphone jack, remove the I-to-J jumper installed in Step 69 in Section III and install a jumper between I and H.

- () Step 4. Plug one end of Motor I Cable into Motor I jack (J8) on Sol rear panel, and plug other end into REMOTE jack on recorder.
- () Step 5. Connect PL259 UHF connector on Video Cable to video output connector on Sol rear panel, and connect other end to video monitor input connector.
- () Step 6. Make sure monitor, recorder and Sol power switches are in their OFF position. Then connect AC power cord to AC receptacle on Sol rear panel and connect Sol, monitor and recorder to appropriate power source.

7.4.2 Terminal Mode Operation

The following procedure assumes your Sol is equipped with a SOLOS personality module.

- () Step 7. Set Sol control switches as follows (see Figure 7-2 on Page VII-7):
 - RST Switch (S1-1): OFF
 - S1-2 (spare): OFF
 - BLANK Switch (S1-3): OFF (display control characters)
 - POLARITY Switch (S1-4): OFF (reverse video display)
 - BLINK Switch (S1-5): OFF (solid cursor)
 - SOLID Switch (S1-6): ON (solid cursor)
 (Step 7 continued on Page VII-7.)

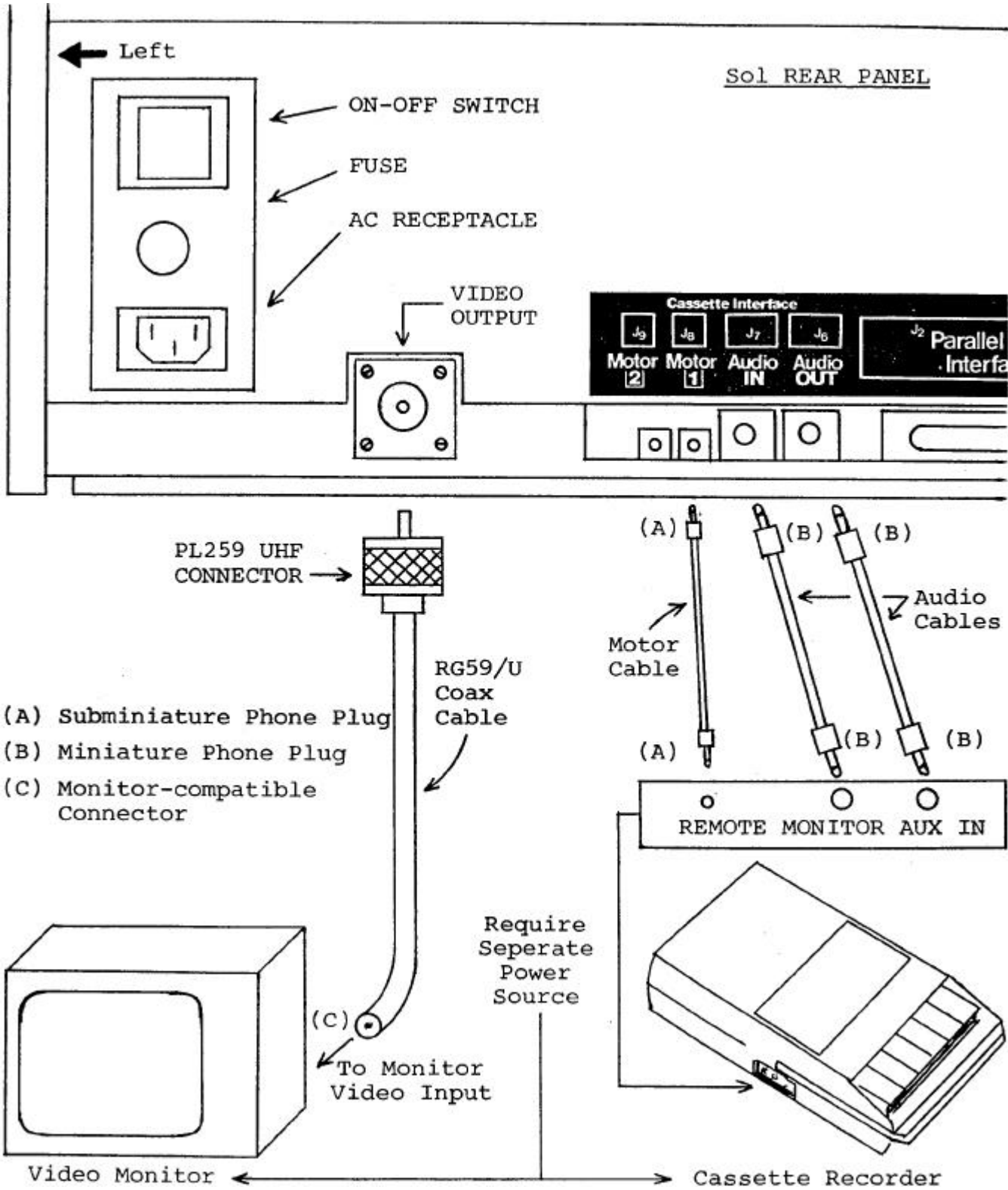

Figure 7-1. Connecting the basic Sol system

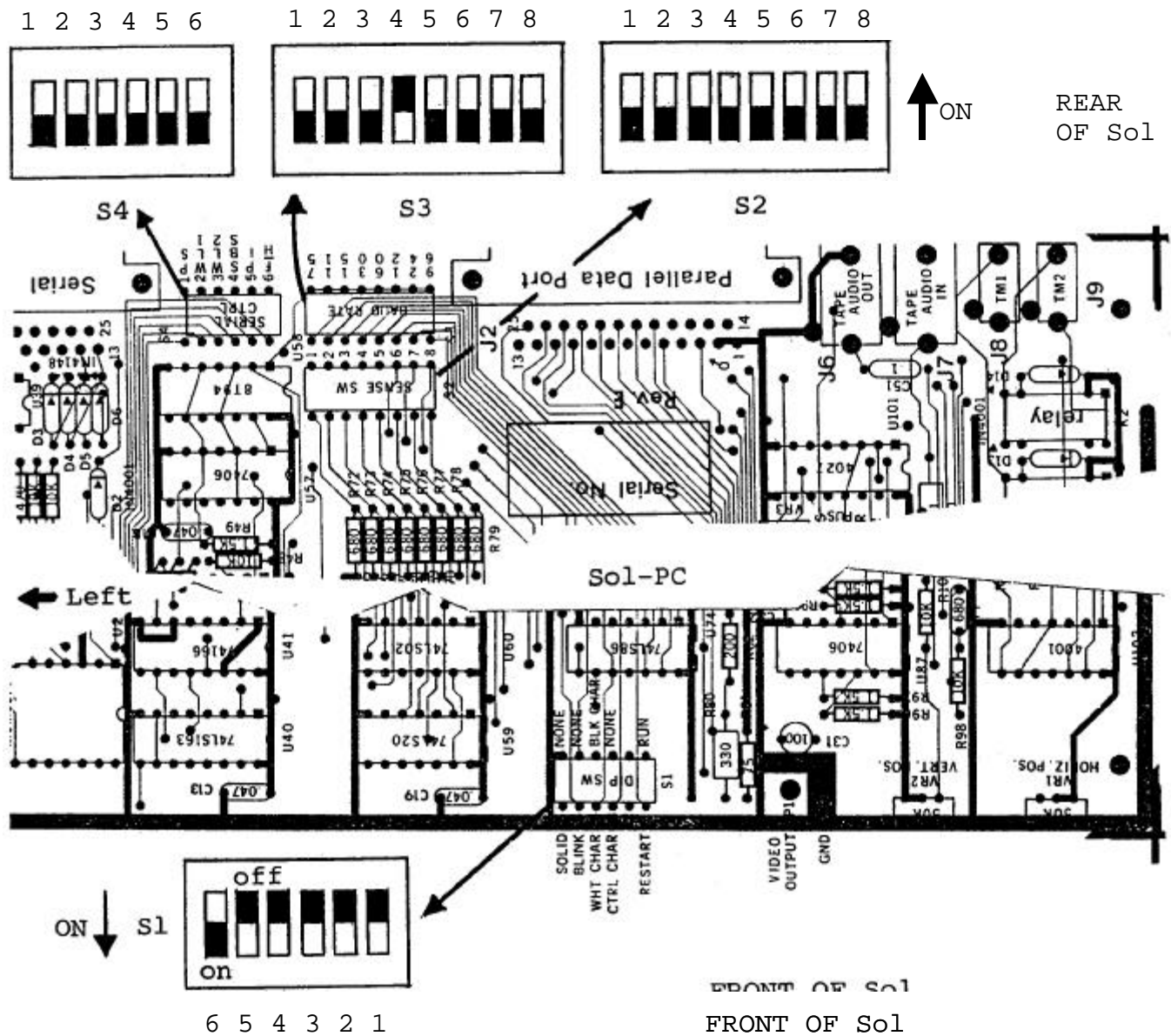

Figure 7-2. Sol control switch settings for terminal mode.

(Step 7 continued.)

SSW Switches (S2-1 - 8): OFF

BAUD RATE Switches (S3-1 - 8): S3-4 ON, all others OFF
(300 Baud)

SDI Switches (S4-1 - 6): OFF (selects full duplex operation,
8 data bits, 2 stop bits and no
parity)

- () Step 8. Turn Sol and monitor on.
- () Step 9. If the monitor display raster is out of sync (black horizontal bar moves slowly down screen, numerous black lines cut across raster, or both), adjust monitor vertical and horizontal hold controls for a stable raster.
- () Step 10. You should see a prompt character followed by the cursor (>■) in the upper left corner of the screen. If you don't, adjust VRI and VR2 (see Figure 7-3) to move the prompt character and cursor onto the screen. (With CONSOL, only the cursor will appear on the screen.)

NOTE

Use VRI (horizontal position) and VR2 (vertical position) to center the display page (16 lines, 64 characters/line) on the screen.

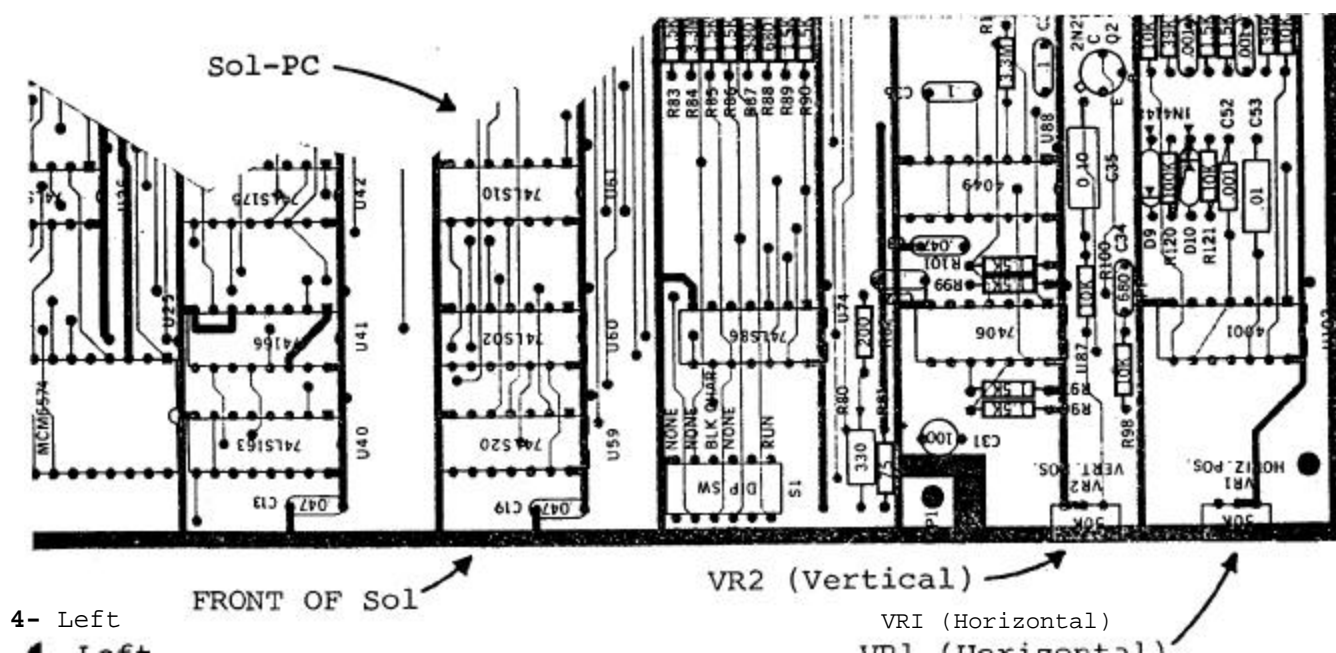

Figure 7-3. Location of positioning adjustments, VRI and VR2.

- () Step II. Enter terminal mode by 1) pressing UPPER CASE key to turn the indicator light on (Alphabetic characters are now entered as upper case, regardless of SHIFT key status, but dual character keys do respond to SHIFT key.), 2) typing TERM and 3) pressing RETURN key. (If your Sol is equipped with CONSOL, it entered terminal mode when you turned the Sol on.) "TERM" will appear on the screen as you type, and the cursor will disappear when you press the. RETURN key.

NOTE: All commands must be given in upper case characters in order to be recognized, and the RETURN key must be pressed after a command so that SOLOS can execute the command (MODE SELECT excepted).

- () Step 12. Set for local operation by pressing LOCAL key to turn indicator light on. Set for lower case operation by pressing UPPER CASE again (indicator light out).
- () Step 13. Press each of the alphanumeric, punctuation and symbol keys. As each is pressed, the lower case character in the UNSHIFTED column of Table 7-4 should appear on the screen. Read Section 7.7 on page VII-17 to become familiar with Table 7-4.

NOTE: If the MODE SELECT key is pressed, SOLOS will return to the command mode and display a prompt character followed by the cursor. In this case return to terminal mode by typing "TERM" in upper case letters, followed by a carriage return.

- () Step 14. Press SHIFT LOCK key to return keyboard to shifted operation (indicator light will go out) and repeat Step 13. Each corresponding upper case character should appear from the SHIFTED column of Table 7-4.
- () Step 15. Use the control sequences given in Table 7-4 on Page VII-18 to generate the indicated control characters. Control characters are generated by pressing the CTRL (control) key and, while holding it depressed, pressing the desired key given in the first column of the table. As the table shows in the last two columns, the symbol generated by a control sequence depends on whether a 6574 or 6575 character generator (U25) is installed in your Sol. Two examples follow:

<u>CONTROL SEQUENCE</u>	<u>6574 SYMBOL</u>	<u>6575 SYMBOL</u>
CTRL and I	→	H _T
CTRL and 5 or %	⊠	E _Q

- () Step 16. Change video display polarity by setting POLARITY Switch (SI-4) to ON and observe the effect on the display. It should change from black characters on a white background to white characters on a black background.
- () Step 17. Switch from non-blinking cursor to a blinking cursor by setting SOLID Switch (SI-6) to OFF and BLINK Switch (SI-5) to ON in that order. You should see a rectangular solid cursor that blinks on and off approximately two times per second. Never put SI-5 and SI-6 ON at the same time.
- () Step 18. Blank control characters by setting BLANK Switch (SI-3) to ON. Any control characters generated (refer to Step should not appear on the screen.

Up to this point, keyboard data has been processed by the CPU, transmitted out through the serial channel output, looped back

to the serial channel input and then displayed on the video monitor. You have consequently just "tested" the CPU, serial channel and display section functions in your Sol.

7.4.3 Command Mode Operation

The following operations assume your Sol is equipped with a SOLOS personality module.

Using the Cassette Recorder. The following procedure for loading a program from cassette tape into Sol memory provides a good example of how to use an audio cassette recorder with Sol. In this example you will use the BASIC/5 cassette supplied with your Sol.

- () Step 19. Set POLARITY (S1-4) and BLANK (S1-3) Switches as desired.
- () Step 20. Replace top and keyboard covers.
- () Step 21. Load BASIC/5 cassette in recorder. If required, fully rewind tape. (This can be done by disconnecting the REMOTE plug from the recorder and using the REWIND control on the recorder.) After rewinding, reconnect REMOTE plug.
- () Step 22. Set the following recorder controls and indicator, if so equipped, as indicated:

Transport: press STOP control

Volume: midrange

Tone: top of range (maximum treble)

Tape Counter: 0

- () Step 23. Press PLAY control on recorder. The tape should not move. If it does, there is a malfunction in the remote control circuitry or cabling. (With the Sol off, there should be no continuity between the REMOTE plug contacts.)

NOTE

The tape head must be clean to reliably read a tape or write on tape.

- () Step 24. If needed, press MODE SELECT key on Sol to enter command mode. (Remember SOLOS initializes in the command mode while CONSOL initializes in the terminal mode whenever Sol is turned on.) You should see a prompt character followed by the cursor (>■) on the left of the screen.

- () Step 25. Type the XEQ command as follows:

XEQ BASIC

- () Step 26. Press the RETURN key on Sol. The cursor should disappear and the tape should advance. The display should not change otherwise. NOTE: With certain cassette recorders or cassettes there may be a misreading of the tape when the splice joining the leader to the tape passes the tape head. In this case an ERROR message will appear and the tape will stop. To resume tape "loading", retype the XEQ BASIC command. If further difficulty is encountered, try different cassette recorder volume settings until a reliable setting is found.
- () Step 27. If the tape has loaded successfully, in approximately two minutes BASIC/5 will display five lines of text ending with:

SOL BASIC 5

READY

- () Step 28. BASIC/5 is now ready for use. Refer to your BASIC/5 User's Manual. Become familiar with both BASIC/5 and the Sol keyboard. Try some exercises in BASIC/5.

Dump Operation. The dump operation displays memory data in hexadecimal on the video monitor. It can also be used with the appropriate SET command to output memory data to a hard-copy device (e.g., a printer). As an example, dump the first part of the SOLOS personality module (C000 through C0E0) as follows:

- () Step 29. Set UPPER CASE key so that the indicator is on. If you are still in BASIC/5, type the BASIC/5 command "BYE" at the beginning of a command line to re-enter SOLOS command mode. BASIC/5 remains in memory and may be returned to by typing a command line: "EXEC 0".
- () Step 30. Type the DUMP command as follows:

DUMP C000 C0E0

- () Step 31. Press RETURN key. Lines of 16 bytes of hexadecimal data will scroll (move) rapidly up the screen until the last address (C0E0) is displayed. At this point the display will stop scrolling.

Enter Operation. The enter operation is used to enter hexadecimal data from the keyboard into available Sol memory. As an example, enter 16 bytes of data, starting at address C900 and ending at address C90F, as follows:

- () Step 32. Type the ENTER command as follows:

ENTER C900

- () Step 33. Press RETURN key. The monitor should display a colon (:) prompt character at the start of the next line.

- () Step 34. Type the following data:

II 22 33 44 55 66 77 88 99 00 AA BB CC DD EE FF/

NOTE

The slash (/) terminates the enter function.

- () Step 35. If you made a mistake in typing the above line of data, refer to Paragraph 7.8.3 on Page VII-25. If you made no mistakes, press RETURN key.

The data entered in Step 34 now resides in locations C900 through C90F in the Sol memory.

- () Step 36. To verify that the data did indeed enter Sol memory, simply give your Sol this DUMP command:

DUMP C900 C90F

Then press RETURN key. The line of data you entered in Step 35 should be displayed on the monitor screen, preceded by the starting address.

- () Step 37. Using your SOLOS User's Manual, experiment with the other commands until you feel at home with your Sol.

The preceding command mode operations used the CPU, personality module, audio cassette interface (ACI) and the Sol RAM. You have consequently just tested the functions of these sections.

7.5 OPERATING CONTROLS IN DEPTH

Unless indicated otherwise, the location of the controls described in this paragraph are shown on the Sol-PC assembly drawing in Section X, Page X-3.

7.5.1 ON-OFF Switch (See Figure 7-1 on page VII-6.)

Push this switch in to turn your Sol on. In the ON position the switch remains locked in its "in" position. To turn your Sol off, push the switch again. This releases the locking mechanism, and the switch will return to its OFF ("out") position.

7.5.2 Restart (RST) Switch, S1-1

This switch permits you to restart your Sol without turning the power off. You should normally leave it in its OFF, or run, position. Set it to ON and then OFF to initialize the Sol circuitry and reset the CPU program counter to zero. (A manual restart with this switch performs the same function as turning the power on or pressing a keyboard generated restart: UPPER CASE key with REPEAT key.)

7.5.3 Control Character Blanking (BLANK) Switch, S1-3

Set this switch to its ON position if you do not want control characters (see Table 7-4 on Page VII-18) to be displayed on the screen. In the OFF position, control characters are displayed.

7.5.4 Video Display (POLARITY) Switch, S1-4

If you want a normal video display (white characters on a black background), set this switch to its ON position. In the OFF position, black characters will be displayed on a white background (reverse video display).

7.5.5 Cursor Selection (BLINK, SOLID) Switches, S1-5 & 6

CAUTION

DO NOT SET S1-5 AND S1-6 TO THEIR ON
POSITIONS AT THE SAME TIME. TO DO SO MAY
DAMAGE YOUR Sol.

If you want the cursor to blink, set S1-6 to OFF and S1-5 to ON. The cursor will blink on and off about two times per second.

Set S1-5 to OFF and S1-6 to ON if you want a non-blinking (solid) cursor.

With both S1-5 and S1-6 in their OFF positions, there will be no cursor display.

7.5.6 Sense (SSW0 - 7) Switches, S2-1 through S2-8

These eight switches are normally left in the OFF position. They are used to manually enter data into the CPU. (They serve the same function as the front panel sense switches on the Altair 8800 and IMSAI 8080.)

S2-1 is the least significant data bit (D100) and S2-8 is the most significant data bit (DIO7). To pull a DIO bit low (when the program tests SSW0 - 7), set the switch associated with the bit to ON. An open (OFF) switch pulls the associated DIO bit high when the program tests SSW0 - 7.

NOTE

The configuration of SSW0 - 7 is tested by the CPU only when it executes an input port FF instruction. Otherwise, the Sense Switches have no bearing on Sol operation.

7.5.7 Baud Rate Switches, S3-1 through S3-8

The setting of the Baud Rate Switches determines the operating speed of the Serial Data Interface (SDI). Assuming you have not installed any of the K, L and M jumper options, you can select any one of eight Baud rates. Table 7-2 on page VII-15 defines Baud rate as a function of S3-1 through S3-8.

CAUTION

DO NOT SET MORE THAN ONE S3 SWITCH TO THE ON POSITION AT THE SAME TIME. TO DO SO CAN DAMAGE YOUR Sol.

7.5.8 Parity (PS, PI) Switches, S4-1 & 5

With these two switches you can select no parity, parity, even parity or odd parity for data handled through the SDI (J1).

Set S4-5 (PI) to its ON position if you want a parity bit. When OFF, there will be no parity bit. (A stop bit immediately follows the data if no parity bit is selected.)

S4-1 (PS) selects even or odd parity if S4-5 is ON. It otherwise has no affect. For even parity, set S4-1 to ON. Set S4-1 OFF for odd parity.

7.5.9 Data Word Length (WLS-I & 2) Switches, S4-2 & 3

Use these two, switches to select the number of bits, excluding parity, in the transmitted word for the SDI. You have a choice of 5, 6, 7 or 8 bits. Table 7-3 defines word length as a function of S4-2 and S4-3.

7.5.10 Stop Bit Selection (SBS) Switch, S4-4

Set this switch to ON if you want one stop bit transmitted out of the SDI. In the OFF position, two stop bits are transmitted unless you have selected a five bit word length. In that case 1.5 stop bits are transmitted.

Table 7-2. Baud Rate Selection With Switch S3.

BAUD RATE	SWITCH S3 CONFIGURATION*
75	S3-1 ON, all others OFF
110**	S3-2 ON, all others OFF
150	S3-3 ON, all others OFF
300	S3-4 ON, all others OFF
600	S3-5 ON, all others OFF
1200	S3-6 ON, all others OFF
2400	S3-7 ON, all others OFF
4800***	S3-8 ON, all others OFF
<p>*Set no more than one switch to ON at the same time.</p> <p>**Rate required by standard 8-level TTY's (Teletype Machine).</p> <p>***Assumes K-to-M jumper on Sol-PC is not installed. With K-M jumper in and L-M trace on back side of Sol-PC cut, SDI operates at 9600 Baud when S3-8 is ON and all others OFF.</p> <p>NOTE FOR REV D Sol-PC BOARDS: With S3-7 ON and all others OFF, Baud rate is either 2400 (K-to-M jumper not installed) or 4800 (K-M jumper in and L-M trace on back side of Sol-PC cut). With S3-8 ON and all others OFF, Baud rate is 9600.</p>	

Table 7-3. Word Length Selection With S4-2 & 3.

WORD LENGTH (Number of Bits)	SWITCH SETTINGS	
	S4-2	S4-3
5	ON	ON
6	ON	OFF
7	OFF	ON
8	OFF	OFF

7.5.11 Full/Half Duplex (F/H) Switch, S4-6

Set this switch to ON if you want half duplex operation in the terminal mode. In half duplex operation, data transmitted out the SDI (J1) is "looped back" and received by the SDI for subsequent

display on the monitor. Use this type of operation when your Sol works with an external computer that does not "echo" data back to the Sol.

For full duplex: operation in the terminal mode, set S4-6 to OFF. Only received data is displayed in full duplex operation. Use full duplex when Sol's transmitted data need not be displayed. (Note that transmitted data from the Sol, if echoed back, is displayed as received data.)

NOTE

If no Baud rate is selected, data will not be transmitted out of the SDI.

7.5.12 Keyboard

The keyboard is an output device that produces ASCII (American Standard Code for Information Interchange) encoded data. It is hardwired to an input port on the Sol and is used for data entry. ASCII data is interpreted by the Sol as data and/or commands as determined by the current system monitor program. The monitor program may be in the personality module, ALS-8, Sol RAM memory or some memory.

7.6 THE KEYBOARD, GENERAL DESCRIPTION

The Sol Terminal Computer has ASCII 96-character keyboard. Its key arrangement conforms with the QWERTY (standard typewriter) format. As shown in the photo on page X-26, there are also 12 control keys (including five basic cursor controls) and seven special function keys. A 15-key arithmetic pad, available as an option on the Sol-10, is provided as standard equipment on the Sol-20.

7.6.1 Operating Features

The Sol keyboard features N-key rollover. That is, several keys can be pressed at the same time without loss of characters or commands. Key entries, however, are in the order of actual key closures. (The keyboard circuitry includes a scanning circuit that prevents simultaneous key operation.)

7.6.2 Keyboard Indicators

Three keys (SHIFT LOCK, UPPER CASE and LOCAL) have indicator lights to indicate keyboard/terminal status. When any of these keys is pressed to turn an indicator light on, the light remains on after the key is released to show that the status persists. Pressing the key again turns the light out to indicate the change in status.

7.7 INDIVIDUAL KEY DESCRIPTIONS

The exact function of most keys on the Sol keyboard is determined by the software used (e.g., the personality module). Others have predefined functions that are common to the CONSOL and SOLOS Personality Modules. (Note that any key that generates a code can be redefined by a program to perform a specific function.) The code generated by each key on the keyboard and the corresponding character, or symbol, produced by the Sol's character generator (U25) are given in Table 7-4 on Pages VII-18 through VII-21.

Table 7-4 has two main headings: 1) KEY which identifies the keys on the Sol keyboard and 2) HEXADECIMAL CODE/CHARACTER GENERATION which specifies for each key the hexadecimal code generated by the keyboard and the symbol produced by the Sol's character generator. The second heading is divided into three major categories: UNSHIFTED, SHIFTED and CONTROL. UNSHIFTED defines the results when operating the keys unshifted (lower case), SHIFTED provides the same information when they are operated shifted (upper case), and CONTROL defines the results of control sequences (refer to Paragraph 7.7.7 on Page VII-22). Within each of these three categories you will find the hexadecimal code generated and the symbol displayed in response to that code by either of the two possible character generators that can be supplied with your Sol, the 6574 and 6575. Some keys move the cursor without displaying a new character.

Looking at the "W" entry on Page VII-18 and reading across the table, we see that:

1. Pressing "W" unshifted would generate the code 77 and either character generator (6574 or 6575) produces a lower case "W" (w). Do not actually press the keys at this point.
2. Pressing "W" shifted would generate the code 57 and either character generator would produce an upper case "W" (W).
3. Pressing CTRL (control) and "W", whether shifted or unshifted, generates the code 17 which causes the 6574 to produce the graphic symbol "-|" for the ASCII "end of transmission block" control character and the 6575 to produce a two-character mnemonic (E_B) for that same control character.

In the following paragraphs, each key function is described in terms of its role in the terminal mode only and assumes the control character display option is enabled and the LOCAL indicator light is on. Many key functions differ from these descriptions in SOLOS command modes BASIC/5, ALS-8, etc. As an aid to learning each key location, we suggest that you keep the keyboard photo, X-26, in view as you study these functions.

7.7.1 Alphanumeric-Punctuation-Symbol Keys

These keys enter the applicable character into the Sol.

PROCESSOR TECHNOLOGY CORPORATION

SOL OPERATING PROCEDURES

SECTION VII

Table 7-4. Sol Keyboard Assignments.

KEY #	HEXADECIMAL CODE/CHARACTER GENERATION								
	UNSHIFTED			SHIFTED			CONTROL		
	Hex. Code	Symbol Displayed*		Hex. Code	Symbol Displayed*		Hex. Code	Symbol Displayed*	
		6574	6575		6574	6575		6574	6575
STANDARD KEYS									
ESCAPE	1B	None	None	1B	None	E _C	1B	None	None
1 !	31	1	1	21	!	!	01	⌈	S _H
2 "	32	2	2	22	"	"	02	⌋	S _X
3 #	33	3	3	23	#	#	03	⌌	E _X
4 \$	34	4	4	24	\$	\$	04	⌍	E _T
5 %	35	5	5	25	%	%	05	⌎	E _Q
6 &	36	6	6	26	&	&	06	⌏	A _K
7 ' /	37	7	7	27	' /	' /	07	⌐	B _L
8 (38	8	8	28	((08	⌑	B _S
9)	39	9	9	29))	09	⌒	H _T
∅	30	∅	∅	20	None	None	00	None	None
- =	2D	-	-	3D	=	=	0D	Return	Return
^ ~	5E	^	^	7E	~	~	1E	⌔	R _S
[{	5B	[[7B	{	{	1B	None	None
\ -	5C	\	\	7C	-	-	1C	⌕	F _S
] }	5D]]	7D	}	}	1D	⌖	G _S
BREAK	None	None	None	None	None	None	None	None	None
TAB	09	→	H _T	09	→	H _T	09	⌗	H _T
Q	71	q	q	51	Q	Q	11	⌘	D ₁
W	77	w	w	57	W	W	17	⌙	E _B
E	65	e	e	45	E	E	15	⌚	E _Q
R	72	r	r	52	R	R	12	⌛	D ₂
T	74	t	t	54	T	T	14	⌜	D ₄
Y	79	y	y	59	Y	Y	19	⌝	E _M
U	75	u	u	55	U	U	15	⌞	N _K
I	69	i	i	49	I	I	09	⌟	H _T

PROCESSOR TECHNOLOGY CORPORATION

SOL OPERATING PROCEDURES

SECTION VII

Table 7-4. Sol Keyboard Assignments. (Continued)

KEY #	HEXADECIMAL CODE/CHARACTER GENERATION								
	UNSHIFTED			SHIFTED			CONTROL		
	Hex. Code	Symbol Displayed*		Hex. Code	Symbol Displayed*		Hex. Code	Symbol Displayed*	
		6574	6575		6574	6575		6574	6575
STANDARD KEYS (Continued)									
O	6F	o	o	4F	O	O	0F	⊙	S _I
P	70	p	p	50	P	P	10	⊠	D _L
@ \	40	@	@	60	\	\	00	None	None
RETURN	0D	←	C _R	0D	←	C _R	0D	Return	Return
LINE FEED	0A	Line Feed	Line Feed	0A	Line Feed	Line Feed	0A	Line Feed	Line Feed
CTRL	None	None	None	None	None	None	None	None	None
SHIFT LOCK	None	None	None	None	None	None	None	None	None
A	61	a	a	41	A	A	01	⌞	S _H
S	73	s	s	53	S	S	13	⊖	D ₃
D	64	d	d	44	D	D	04	↘	E _T
F	66	f	f	46	F	F	06	↙	A _K
G	67	g	g	47	G	G	07	↖	B _L
H	68	h	h	48	H	H	08	↗	B _S
J	6A	j	j	4A	J	J	0A	Line Feed	Line Feed
K	6B	k	k	4B	K	K	0B	↓	V _T
L	6C	l	l	4C	L	L	0C	↘	F _F
; +	3B	;	;	2B	+	+	0B	↙	V _T
: *	3A	:	:	2A	*	*	0A	Line Feed	Line Feed
DEL _	7F	None	None	5F	Delete	Delete	1F	⊠	U _S
REPEAT	None	None	None	None	None	None	None	None	None
CTRL	None	None	None	None	None	None	None	None	None
UPPER CASE	None	None	None	None	None	None	None	None	None
SHIFT	None	None	None	None	None	None	None	None	None
Z	7A	z	z	5A	Z	Z	1A	⌞	S _B
X	78	x	x	58	X	X	18	⊗	C _N
C	63	c	c	43	C	C	03	⌞	E _X

*See notes at end of this table. Page VII-21.

PROCESSOR TECHNOLOGY CORPORATION

Sol OPERATING PROCEDURES

SECTION VII

Table 7-4. Sol Keyboard Assignments. (Continued)

KEY #	HEXADECIMAL CODE/CHARACTER GENERATION								
	UNSHIFTED			SHIFTED			CONTROL		
	Hex. Code	Symbol Displayed*		Hex. Code	Symbol Displayed*		Hex. Code	Symbol Displayed*	
		6574	6575		6574	6575		6574	6575
STANDARD KEYS (Continued)									
V	76	v	v	56	V	V	16		S _Y
B	62	b	b	42	B	B	02		S _X
N	6E	n	n	4E	N	N	0E		S _O
M	60	m	m	40	M	M	0D	Return	Return
, <	2C	,	,	3C	<	<	0C		F _F
. >	2E	.	.	3E	>	>	0E		S _O
/ ?	2F	/	/	3F	?	?	0F		S _I
SHIFT	None	None	None	None	None	None	None	None	None
LOCAL	None	None	None	None	None	None	None	None	None
Space Bar	20	None	None	20	None	None	20	None	None
ARITHMETIC PAD KEYS									
-	2D	-	-	2D	-	-	2D	-	-
*	2A	*	*	2A	*	*	2A	*	*
÷	2F	/	/	2F	/	/	2F	/	/
7	37	7	7	37	7	7	37	7	7
8	38	8	8	38	8	8	38	8	8
9	39	9	9	39	9	9	39	9	9
4	34	4	4	34	4	4	34	4	4
5	35	5	5	35	5	5	35	5	5
6	36	6	6	36	6	6	36	6	6
1	31	1	1	31	1	1	31	1	1
2	32	2	2	32	2	2	32	2	2
3	33	3	3	33	3	3	33	3	3
∅	30	∅	∅	30	∅	∅	30	∅	∅
.	2E	.	.	2E	.	.	2E	.	.
+	2B	+	+	2B	+	+	2B	+	+

KEY#	HEXADECIMAL CODE/CHARACTER GENERATION								
	UNSHIFTED			SHIFTED			CONTROL		
	HEX. Code	Symbol Displayed*		HEX. Code	Symbol Displayed*		HEX. Code	Symbol Displayed*	
		6574	6575		6574	6575		6574	6575
SPECIAL KEYS									
LOAD	8C	None	F _F	8C	None	F _F	8C	None	F _F
MODE SELECT	80	None	None	80	None	None	80	None	None
↑	97	None	None	97	None	None	97	None	None
←	81	None	None	81	None	None	81	None	None
→	93	None	None	93	None	None	93	None	None
↓	9A	None	None	9A	None	None	9A	None	None
HOME CURSOR	8E	None	None	8E	None	None	8E	None	None
CLEAR	8B	None	None	8B	None	None	8B	None	None
#Vertical line between characters indicates dual character key. *Character generated is displayable and transmittable. "None" means no code is generated or no symbol is displayed. Return is defined in Section 7.7.11, and line feed in Section 7.7.12, on page VII-24.									

7.7.2 Space Bar

Pressing the Space Bar, shifted or unshifted, generates the ASCII space code (20) and moves the cursor one space to the right.

7.7.3 Arithmetic Pad Keys

Except for the division symbol key (/), these keys enter the applicable character into the Sol. The division symbol key enters a forward slash (/) character. SHIFT does not affect these keys.

The arithmetic pad is useful for entering large amounts of numerical data. Each key in the pad duplicates its corresponding numeric, period (decimal point), dash (minus), plus (addition), asterisk (multiplication) and forward slash (division) key in the "typewriter" group of keys. That is, pressing one of the pad keys does the same thing as pressing its corresponding key in the "type-writer" group.

7.7.4 ESCAPE Key

Pressing ESCAPE, shifted or unshifted, generates the ASCII escape character (1B). The character is displayed.

7.7.5 BREAK Key

Pressing BREAK, shifted or unshifted, forces the SDI output line to a space level for as long as the key is depressed. No character is displayed. (Some communications systems use this feature.)

7.7.6 TAB Key

Pressing TAB, shifted or unshifted, generates the ASCII horizontal tab character (09). The character is displayed.

7.7.7 Control (CTRL) Key

CTRL, shifted or unshifted, is used with alphanumeric, punctuation and symbol keys to initiate functions or generate the characters defined in Table 7-4. Table 7-5 defines the ASCII control characters. The characters in Table 7-5 are not always displayed on the video monitor.

A control sequence (e.g., CTRL plus J, which produces ASCII line feed) requires that CTRL be pressed first and held down while the other key or keys are pressed in sequence.

7.7.8 SHIFT Key and SHIFT LOCK Key/Indicator

The SHIFT key generates no code and is thus not displayed. It is interpreted as a direct internal operation, and when pressed specifically shifts the keyboard from lower case to upper case and from the lower to upper character on dual character keys as on a typewriter. The keyboard remains in upper case as long as SHIFT is held down.



































Pressing SHIFT LOCK to turn the indicator light on electronically locks the SHIFT key in the upper case position. Again, no code is generated and no character is displayed. Pressing SHIFT returns the keyboard to lower case and causes the SHIFT LOCK indicator light to go out.

7.7.9 UPPER CASE Key/Indicator

Pressing this key, shifted or unshifted, to turn the indicator light on activates the upper case keyboard function so that all alphanumeric characters entered from the keyboard, regardless of SHIFT key status, are transmitted as upper case characters. (Dual character keys, however, do respond to the SHIFT key.) With the indicator light on, the Sol keyboard essentially simulates a teletype (TTY) keyboard.

Pressing UPPER CASE to turn the indicator light off returns the keyboard to normal SHIFT key operation.

Table 7-5. Control Character Symbols and Definitions.

HEXADECIMAL CODE	SYMBOL GENERATED BY		DEFINITION
	6574 Generator	6575 Generator	
06		AK	Acknowledge
07		BL	Bell
08		BS	Backspace
18		CN	Cancel
0D		CR	Carriage Return
11		D1	Device Control 1
12		D2	Device Control 2
13		D3	Device Control 3
14		D4	Device Control 4
7F			Delete
10		DL	Data Link Escape
17		EB	End of Transmission Block
1B		EC	Escape
19		EM	End of Medium
05		EQ	Enquiry
04		ET	End of Transmission
03		EX	End of Text
0C		FF	Form Feed
1C		FS	File Separator
1D		GS	Group Separator
09		HT	Horizontal Tab
0A		LF	Line Feed
15		NK	Negative Acknowledge
00		NU	Null
1E		RS	Record Separator
1A		SB	Substitute
01		SH	Start of Heading
0F		SI	Shift In
0E		SO	Shift Out
02		SX	Start of Text
16		SY	Synchronous Idle
1F		US	Unit Separator
0B		VT	Vertical Tab

7.7.10 LOCAL Key/Indicator

The LOCAL key internally connects the SDI output to the SDI input and disables serial transmission. No character is displayed. Pressing LOCAL, shifted or unshifted, to turn the indicator light on sets Sol for local operation. Keyboard entries are not transmitted, but they are "looped back" to the SDI input for display. That is, Sol is not on "line". Pressing LOCAL to turn the light off ends local operation. This corresponds to the local/line operation of a TTY.

7.7.11 RETURN Key

Pressing RETURN, shifted or unshifted, generates the ASCII carriage return character (0D), which is not displayed, and moves the cursor to the start of the line on which it resided prior to RETURN being depressed. (This is the same action as a TTY carriage return.) RETURN also erases all data in the line to the right of the cursor.

7.7.12 LINE FEED Key

Pressing LINE FEED, shifted or unshifted, generates the ASCII line feed character (0A), which is not displayed, and moves the cursor vertically downward one line. (This is the same action as a TTY line feed.) Line feed action does not erase any data in the line to the right of the cursor.

7.7.13 LOAD Key

The LOAD key character is displayed, but the key is non-functional with CONSOL and SOLOS. The code generated by this key is 8C, and it may be used by a program to meet a specific need.

7.7.14 REPEAT Key

The REPEAT key generates no character and is consequently not displayed. Pressing REPEAT, shifted or unshifted, and another key at the same time causes the other key to repeat at an approximate rate of 15 times per second as long as both keys are held down. Pressing REPEAT at the same time as UPPER CASE performs a restart. See Section 7.5.2 on page VII-13.

7.7.15 MODE SELECT Key

Pressing this key, shifted or unshifted, generates the code 80 and causes Sol to enter the command mode.

7.7.16 CLEAR Key

Pressing CLEAR, shifted or unshifted, erases the entire screen and moves the cursor to its "home" position (upper left corner of the screen).

7.7.17 Cursor Control (HOME CURSOR and Arrows) Keys

Five keys control basic cursor movement. They are HOME CURSOR and the four keys with arrows. None are affected by SHIFT status, and none are displayed or transmitted.

Pressing HOME CURSOR moves the cursor to its home position--the first character position in the upper left corner of the screen.

To move the cursor up, down, left or right, press the applicable "arrow" key. Each time you press a key the cursor moves one unit in the direction you wish--one space horizontally or one line vertically. These keys may be used with REPEAT. The cursor will not move across any margin of the screen with these four keys.

7.8 BASIC OPERATIONS

7.8.1 Switching From Terminal To Command Mode

To switch from terminal to command mode, simply press the MODE SELECT key. Sol enters the command mode, issues a prompt character (>) and waits for a command input.

7.8.2 Switching From Command To Terminal Mode

To switch from command to terminal mode, press UPPER CASE, TERM and RETURN in that order. Sol enters the terminal mode and all keyboard data will be sent to the SDI output and all data received (including "looped back" data) will appear on the screen.

7.8.3 Entering Commands In The Command Mode

The various commands for CONSOL and SOLOS are described in Section IX of this manual and the SOLOS Users' Manual respectively.

You can place more than one command on the screen. For each command, use the arrowed cursor control keys to position the cursor at the start of a new line and begin the new command line with a prompt character (>).

A command is executed when you press the RETURN key, and all characters on the line to the left of the cursor are interpreted as the command. This means that if more than one command line is on the screen, you can execute any one of them as follows: position the cursor with the arrowed cursor control keys to the right of the desired command and press RETURN.

Should you make a mistake when entering a command, there are two ways to correct it:

(Paragraph 7.8.3 continued on Page VII-26.)

1. If you see the error immediately (the error is to the immediate left of the cursor), press the DEL key (unshifted) to erase the mistake. Then make the correction.
2. If the error is more than one character position to the left of the cursor, use the arrowed cursor control keys to position the cursor over the mistake. Then make the correction

7.8.4 Keyboard Restart

To perform a keyboard restart, press the UPPER CASE and REPEAT keys at the same time. This key combination performs the same function as a power on initialization or setting the RST switch to ON. Use the keyboard restart to return to SOLOS/CONSOL from 1) a program which does not recognize the MODE SELECT key or 2) a program that is stuck in an endless loop.

7.9 Sol-PERIPHERAL INTERFACING

7.9.1 Audio Cassette Recorders

Your Sol is capable of controlling one or two recorders. The interconnect requirements for one recorder were previously covered in Paragraph 7.4.1 in this section.

Since the Sol has only one audio input and one audio output jack, however, the interconnect requirements for two recorders are somewhat different than for one.

You will need two "Y" adapters, one to feed the single Sol audio output to the AUXILIARY input of two recorders and the other to feed the MONITOR output of two recorders to the single Sol audio input. (If you intend to use the Audio In and Out cables described in Paragraph 7.4.1 in this section, miniature phone jack-to-two miniature phone plug adapters are required.) Since the recorder outputs are most likely unbalanced, we also suggest that you incorporate 1000 ohm resistors in the MONITOR adapter as shown in Figure 7-5 on Page VII-29. Figure 7-5 also illustrates, in schematic form, how to connect two recorders to your Sol.

When using two recorders you may read or write to both under program control as well as read one tape while writing on the other. If you intend to read one tape while writing on the other, however, you may have to disconnect the MONITOR plug from the write unit, with the need for disconnect being determined by the recorder design. The MONITOR disconnect must be made if the recorder has a

"monitor" output in the record mode. (Panasonic RQ-413S and RQ-309DS do, for example.)

NOTE 1

Recorders on which the "monitor" jack is labeled MONITOR usually provide a monitor output in the record mode. If the jack is labeled EAR or EARPHONE, the recorder usually does not provide a monitor output in the record mode.

NOTE 2

To determine if your recorder provides a monitor output in the record mode, install a blank tape, plug earphone into "monitor" jack and microphone into MICROPHONE jack, set recorder controls to record, and speak into microphone while listening with the earphone. If you hear yourself through the earphone, your recorder does provide a monitor output in the record mode.

Write Operations. Other than placing the recorder(s) in the record mode, loading the cassette(s) and making sure that the head(s) is on tape (not leader), no manual operations are needed to write on tape.

In the case of two recorders, however. Unit 1 and 2 must be specified in the SAVE command in order to select the desired recorder. A default selects Unit 1. Refer to your SOLOS Users' Manual for instructions on how to use tape commands.

Read Operations. In order to read a specific file on tape, you must start the tape at least two seconds ahead of that file. This delay allows the Sol audio cassette interface circuitry and the recorder playback electronics to stabilize after power is turned on. Since all file searches are in the forward direction, the simplest approach is to fully rewind the cassette(s) before a read operation unless you know that the file of interest is advanced at least two seconds. (See Paragraph 7.4.3, Step 21 for instructions on how to rewind the tape.)

For a read operation, proceed as follows:

1. Load cassette(s) as just described.
2. If only one recorder is used, set its volume control at midrange. With two recorders, set both volume controls at their high end.

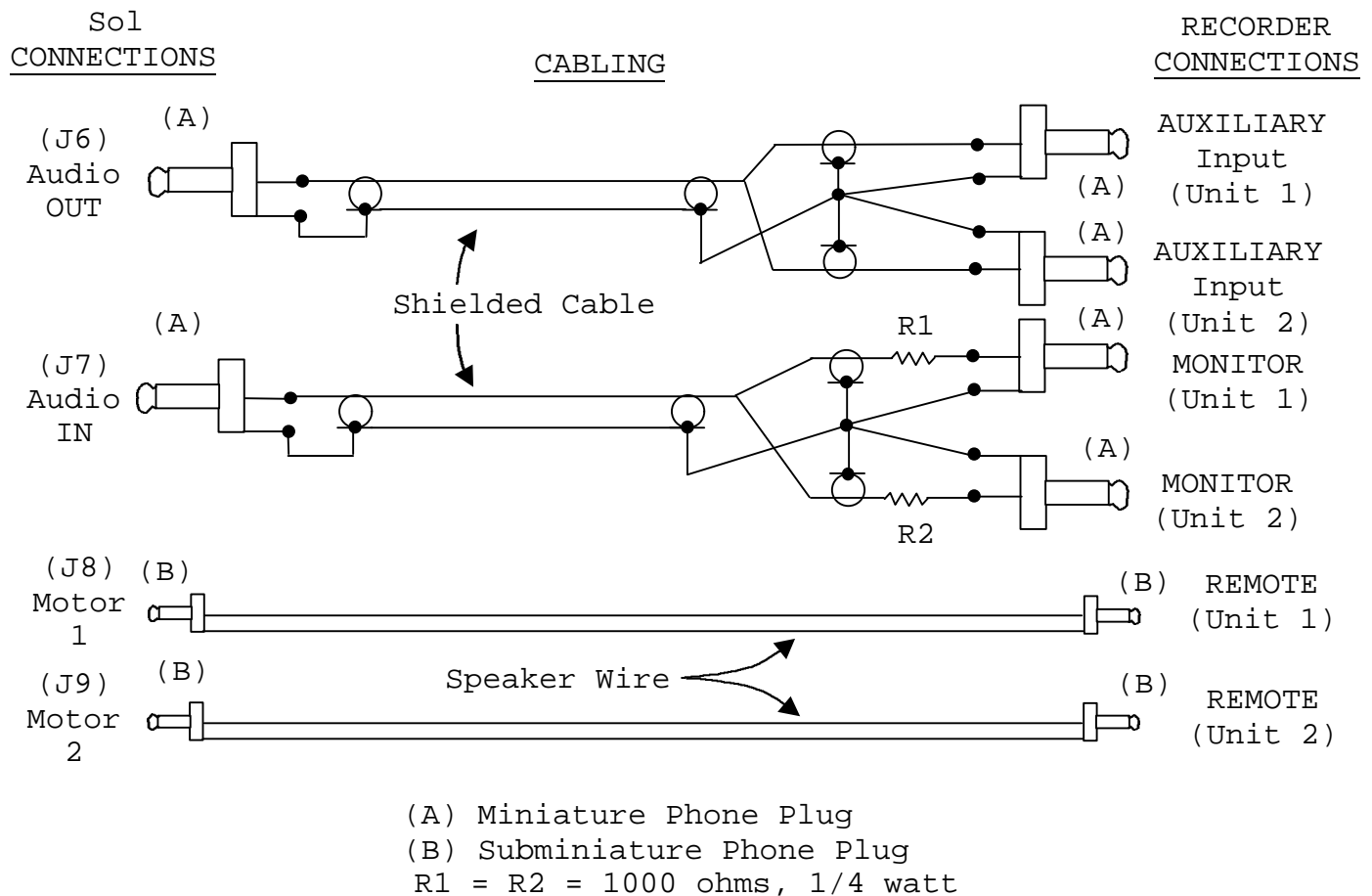

Figure 7-5. Connecting Sol to two cassette recorders

3. Set recorder(s) tone control(s) at the top of the range (maximum treble).
4. Set PLAY control(s) for playback mode.
5. Give Sol the GET or "GET, then Execute" command as appropriate. (Refer to your SOLOS Users' Manual for instructions on how to use tape commands.)

7.9.2 Serial Data Interface (SDI)

The Sol Serial Data Interface (J1) is capable of driving an RS-232 device, such as a modem, or a current loop device, such as the ASR33 TTY.

S3 (Baud Rate) and S4 (Parity, Word Length, Stop Bits and Full/Half Duplex) are used to select the various serial interface options as described in Paragraphs 7.5.7 through 7.5.11 in this section.

Set S3 switches to select the Baud rate required by the modem or current loop device. (Standard 8-level TTY's operate at 110 Baud, S3-2 ON and all other S3 switches OFF.) For standard 8-level TTY's and most modems, set all S4 switches OFF. (This selects eight data bits, two stop bits, no parity bit and full duplex operation for the SDI.

Figures 7-6 and 7-7 show examples of current loop and modem interconnections to the Sol SDI connector (J1). The ASR33 TTY is used to illustrate a current loop interconnect, and the Bell 103 modem is used to illustrate a modem interconnect.

When operating in the terminal mode and full duplex. Sol keyboard data is transmitted out on Pin 2 of J1 and data received on Pin 3 of J1 is displayed on the video monitor. In the command mode, SOLOS set in and out commands can be used to channel output data and input data through the SDI. (Refer to your SOLOS Users' Manual for instructions on how to use the set commands.)

In either mode, the LOCAL key directly controls the SDI. With the LOCAL indicator light on, received data is ignored and keyboard data is not transmitted. It is, however, looped back for display on the video monitor. With the LOCAL light off, received data is displayed and keyboard data is transmitted but not displayed unless it is echoed back.

7.9.3 Parallel Data Interface (PDI)

The Sol Parallel Data Interface (J2) is used to drive parallel devices such as paper tape readers/punches and line printers. It provides eight output data lines, eight input data lines, four handshaking signals and three control signals. The latter allow up to four devices to share the PDI connector. (See Appendix VII for J2 pinouts.)

The port address for parallel input and output data is FD (hexadecimal), and the control port address for the PDI is FA (hexadecimal). PXDR is available at bit 2 of port FA. When this bit is set to 0, the external device is ready to receive a byte of data. PDR is available at bit 1 of port FA, with 0 indicating the external device is ready to send a byte of data. Parallel Unit Select (PUS) is controlled by bit 4 of port FA. The input and output enable lines are available for tri-stating an external two-way data bus.

Use of the three control signals is optional and is unnecessary when only one device is connected to the PDI connector.

(Paragraph 7.9.3 continued on Page 31.)

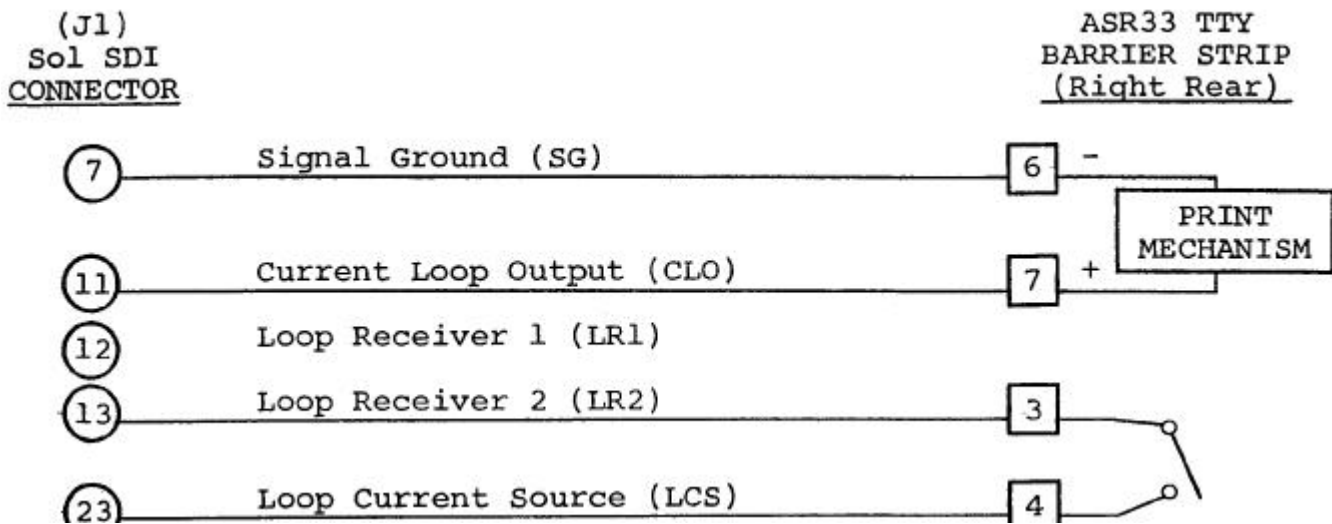

CAUTION: PINS 1 AND 2 ON TTY BARRIER STRIP CARRY 120 V ac LINE VOLTAGE.

Figure 7-6. Connecting Sol SDI to current loop device such as TTY.

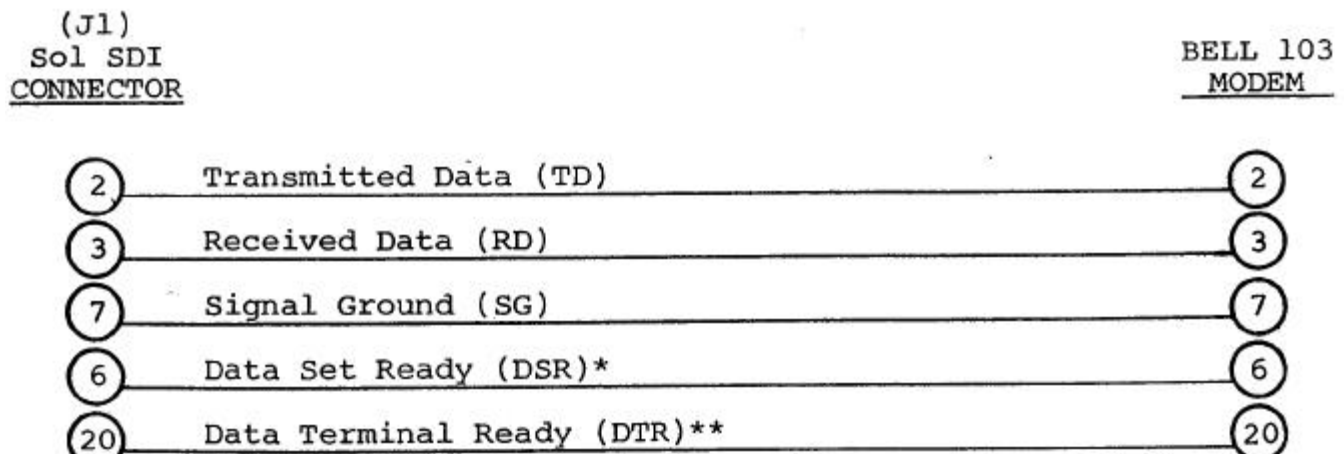

*Available at bit 1 of port F8. Terminal mode software (SOLOS et al) does not use this signal and transmits data whether or not the modem is ready.

**Sol is wired so that DTR indicates a ready condition whenever power is on.

Figure 7-7. Connecting Sol SDI to communications modem.

In Figure 7-8, the Oliver OP80 Manual Paper Tape Reader is used to illustrate a typical PDI interconnect.

7.10 CHANGING THE FUSE

Sol is protected with a 3.0 amp Slo-Blo fuse housed on the rear panel (see Figure 7-1 on Page VII-6). To remove the fuse, turn Sol off, disconnect power cord, turn fuse post cap one quarter turn counterclockwise, pull straight out and remove fuse from cap.

To install a fuse, insert fuse in cap, push in and turn one-quarter turn clockwise.

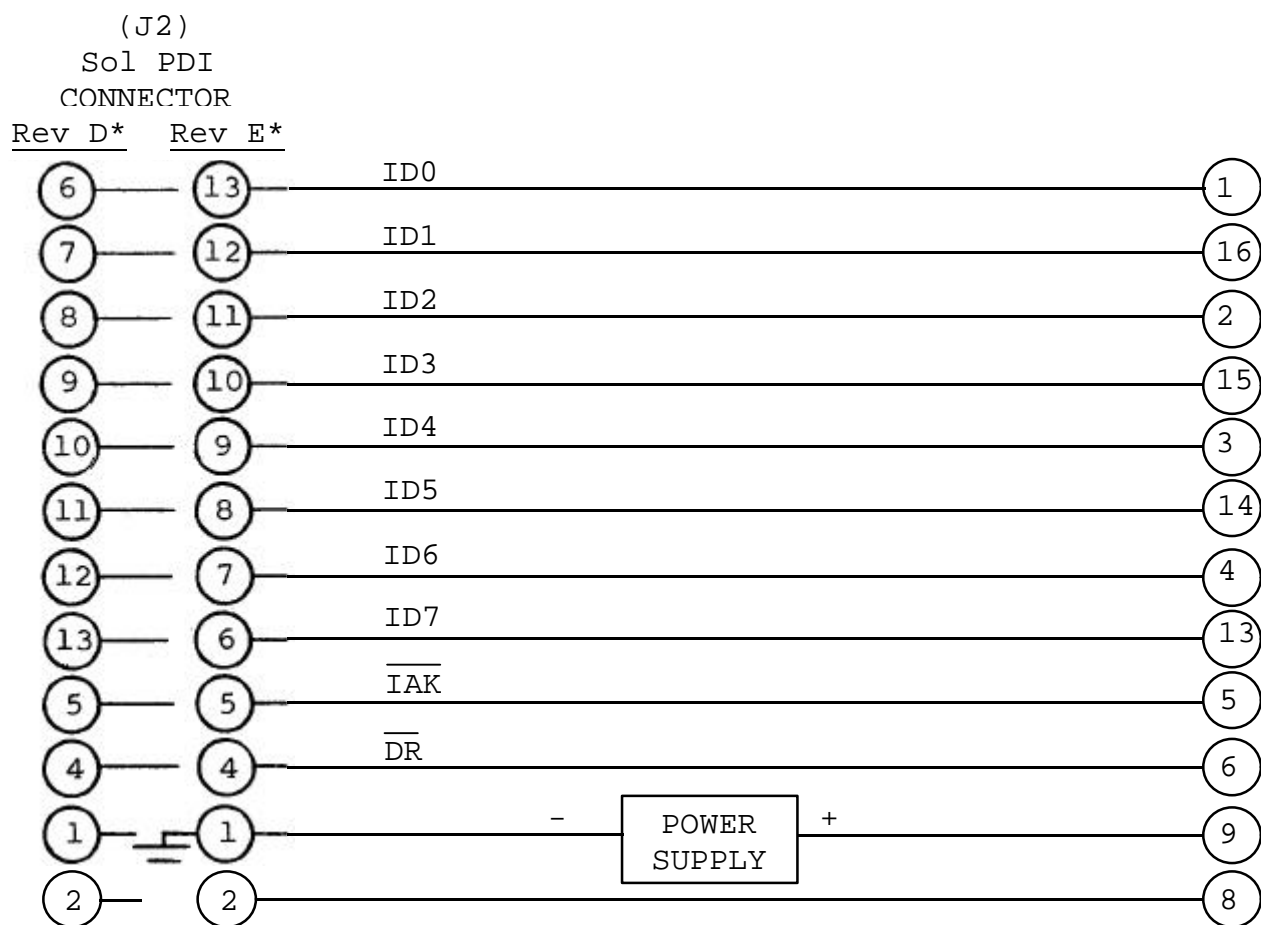

NOTE: +5 V dc is not available at J2. The use of an external +5 V dc power supply with its ground connected to Pin 1 of J2 (Sol chassis ground) is recommended.

*Sol-PC Board

Figure 7-8. Connecting Sol PDI to parallel device.