



INTERNAL CORRESPONDENCE

TO: List

DATE: March 26, 1980

FROM: R. Hoskin ^{PH}

SUBJECT: ECO Matrix and rework for IPB, IOC, DRR Boards REV 3

The following is an up-date to the matrix released on March 24. Please discard the previous issues.

This document contains the rework required to up-grade the IOC, IPB, DRR Channel and interface boards to the latest correct dash and REV level.

Please take note that changes have been made in the level in which a board may be scrapped for the IPB (1001194) and the IOC (1001241).

LIST:

L. Adams
G. Anderson
A. Banani
L. Brown
D. Burkhardt
Y. Doi
C. Ferris
R. Hall
J. Haynes
B. Mihalus
B. Reed
D. Schmidek
A. Tanabe
A. Templeton
B. Tunmore
J. Watt
L. Weigert

Service Support:

C. Feetham
M. Gee
K. Hahn
R. Hoskin
D. Jackson
L. Johnson
R. Skipper
K. Kremer

Document Files:

1002321
1001194
1002104
1001241
1001036
1000467

TABLE OF CONTENTS

- 1.0 IPB 20 Bit Address - 4 Layer - PWA 1002321
- 2.0 IPB 2 Layer PWA 1001194
- 3.0 IOC 4 Layer PWA 1002104
- 4.0 IOC 2 Layer PWA 1001241
- 5.0 DDR Interface Board PWA 1001036
- 6.0 DDR Channel Board PWA 1000467

IPB 20 BIT ADDRESS - 4 LAYER

<u>P/N</u>	<u>DASH</u>	<u>REV LEVEL</u>	<u>ECO REQUIRED</u>
1002321-03		K	None
1002321-03		J	13-5762
1002321-03		H	2-5279, 13-5762
1002321-03		G	2-5158, 2-5279, 13-5762
0112321-03		F	2-4983, 2-5158, 2-5279, 13-5762
1002321-02		E	2-4594, 2-4983, 2-5158, 2-5279, 13-5762
1002321-02		D	2-4594, 2-4556A, 2-4983, 2-5158, 2-5279, 13-5762
1002321-02		C	2-4594, 2-4556A, 2-4463A, 2-4983, 2-5158, 2-5279, 13-5762
1002321-02		B	2-5494, 2-4556A, 2-4463A, 2-4983, 2-5158, 2-5279, 13-5762
1002321-01		A	2-3231, 2-4594, 2-4556A, 2-4463A, 2-4983, 2-5158, 2-5279, 13-5762
1002321-01		1	2-3213, 2-4594, 2-4556A, 2-4463A, 2-4983, 2-5158, 2-5279, 13-5762

- ECO 2-4463A - Increases drive to opto-isolator
- ECO 2-4556A - Change IC Socket to more reliable type
- ECO 2-4594 - Improve Prom Strobe to accommodate EMDS 201
- ECO 2-3213 - Update board with faster parts
- ECO 2-4983 - Parts list change - no rework
- ECO 2-5158 - Manufacturing change - no field rework
- ECO 2-5279 - Manufacturing change - no field rework
- ECO 13-5762 - Parts list change - no rework

-- All 1002321's which are shipped must be the latest dash and REV level or reworked to the latest dash or REV level.

-- 1002321-01 REV 1 and REV A must be reworked with ECO's 2-3213, 2-4594, 2-4556A, 2-4463A. When these ECO's are incorporated, re-identify the PWA as 1002321-03, REV K. Stamp or mark on the solder side of the board, ECO 2-3213, 2-4594, 2-4556A, 2-4463A, 2-4983, 2-5158, 2-5279, 13-5762.

- 1002321-02 REV B and C must be reworked with ECO's 2-4594, 2-4556A and 2-4463A. When these ECO's have been incorporated, re-identify the PWA as 1002321-03, REV K. Stamp or mark on the solder side of the board, ECO 2-4594, 2-4556A, 2-4463, 2-4983, 2-5158, 2-5279, 13-5762.
- 1002321-02 REV D must be reworked with ECO's 2-4594, 2-4556A. When these ECO's have been incorporated, re-identify the PWA as 1002321-03 REV K. Stamp or mark on the solder side of the board, ECO's 2-4594, 2-4556A, 2-4983, 2-5158, 2-5279, 13-5762.
- 1002321-02 REV E must be reworked with ECO 2-4594. When ECO 2-4594 has been incorporated, re-identify the PWA as 1002321-03, REV K. Stamp or mark on the solder side of the board, ECO 2-4594, 2-4983, 2-5158, 2-5279, 13-5762.
- 1002321-03 REV F will not require field rework. These ECO's 2-4983, 2-5158, 2-5279, 13-5762 are manufacturing or parts list changes. RE-identify the PWA as 1002321-03 REV K.

* See attached details on each ECO *

REWORK INSTRUCTIONS

ECO 2-4463

1. Remove IC R32 and R36 (56-024).
2. Replace R32 and R36 with P/N 56-097. (680Ω , $\pm 5\%$, $\frac{1}{4}W$)

REWORK INSTRUCTIONS

ECO 2-4594A

1. Replace IC 101502-001 in location A70 with IC 102899-001.
2. Remove A54 pin 2 from pad on the board and bend lead straight out from body of IC

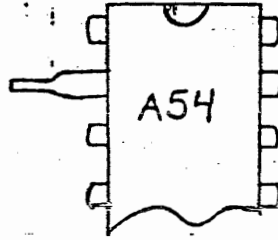

3. On solder side, cut the trace running from RP9-3 to the feed thru located near A84-9. (See figure 1).

FIGURE 1

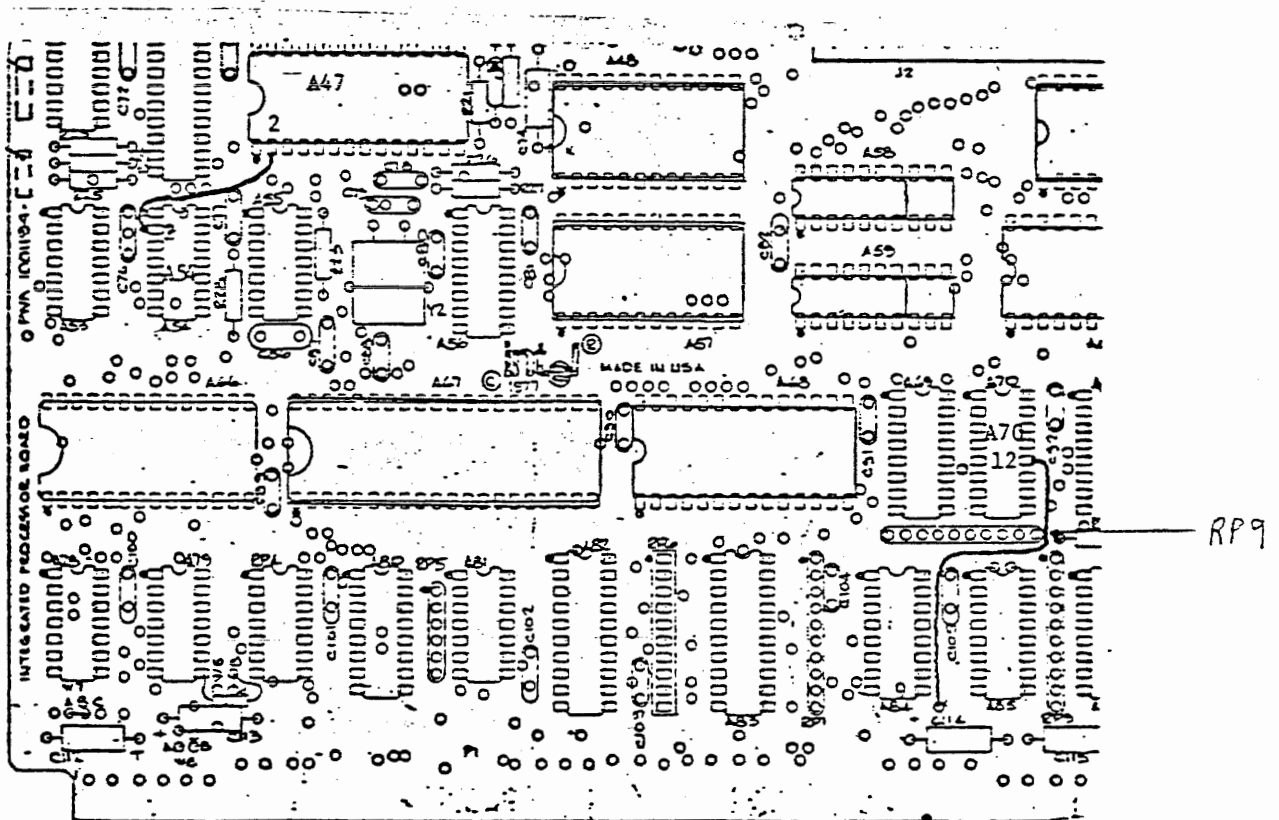

4. On component side, install a jumper from the feed thru located below and to the right of A84-9 to A70-12.
5. On component side, install a jumper from the lead of A54-2 to A47-2.

REWORK INSTRUCTIONS

ECO 2-3213A

1. Remove A62 and A74 and replace with 101190-001 (Intel IC 8251A).
2. Remove all (74S74) and replace with 100914-001 (74LS74).
3. Remove C40 and replace with 101754-055 (.33 μ F, \pm 20%).
4. Remove R10 (33K 5% 1/4W) and replace with 101656-008 (39K 5% 1/4 RES).
5. Remove RP5 and replace with RES-PACK 101729-028.
6. Remove A66 (Intel P/N 52-104) and replace with 101185-001 (Intel P/N 8218).

REWORK INSTRUCTIONS

ECO 2-4556A

1. Remove the 8080 at location A67.
2. Inspect the 40 pin socket for the type shown below:

The 40-pin sockets to be replaced are Intel P/N 101555-040 (typical example shown below):

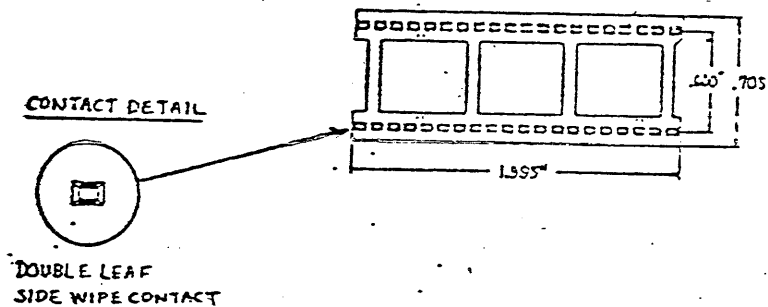

Typical manufacturers are: Robinson-Nugent (shown above)
SAE
Burndy

3. If PWA does have the above sockets, remove all 40-pin sockets shown above.
If PWA does not have this type of socket, replace IC's in sockets (socket is then of the right type).
4. Replace 40-pin socket with Scanbe or Augat type socket (P/N 101581-040 or 102989-001).
5. Replace IC into socket.

ECO 2-4983

Parts list change - no rework

ECO 2-5158

Manufacturing change - no field rework
- Change to cap with preformed leads -

ECO 2-5279

Manufacturing Change - no field rework
- install sockets at A6, A69, A70, and
A71 to reduce trouble shooting problems -

ECO 13-5762

- Parts list change - no rework -

IPB 2 LAYER

<u>P/N DASH</u>	<u>REV LEVEL</u>	<u>ECO REQUIRED</u>
1001194-04, 05, 06	B	***
1001194-01, 02, 03	A, 20	2-4782
1001194-01, 02, 03	19	2-4782, 2-2920
1001194-01, 02, 03	18	2-4782, 2-2920, 2-2365
1001194-01, 02, 03	17	2-4782, 2-2920, 2-2365, 2-2210
1001194-01, 02, 03	16	2-4782, 2-2920, 2-2365, 2-2210, 2-2116
1001194-01, 02, 03	15	2-4782, 2-2920, 2-2365, 2-2210, 2-2116, 2032
1001194-01, 02, 03	14	2-4782, 2-2920, 2-2365, 2-2210, 2-2116, 2032, 1971, 2082
1001194-01, 02, 03	13	2-4782, 2-2920, 2-2365, 2-2210, 2-2116, 2032, 1971, 2082, 1946
1001194-01, 02, 03	12	2-4782, 2-2920, 2-2365, 2-2210, 2-2116, 2032, 1971, 2082, 1946, 1945

Scrap all 1001194-01, 02, 03 REV 11 and below (per engineering)

ECO 1945	Add choke to clock line
ECO 1946	Add sockets - manufacturing change only (no rework)
ECO 2082	Monitor change
ECO 1971	Monitor change
ECO 2032	Parts list change - record change (no rework)
ECO 2-2116	Parts list change (no rework)
ECO 2-2210	InH Data strobe (ICE 85)
ECO 2-2365	VRI mounting hardware - manufacturing change only (no rework)
ECO 2-2920	Change bus time out to accomodate ICE 41
ECO 2-4782	Expansion chassis fix
***	20 Bit address fix

All 1001194's which are shipped must be the latest dash and REV level or reworked to the latest dash or REV level.

--- 1001194-01, 02, 03 REV 12 will require ECO's 2-4782, 2-2920, 2-2365, 2-2210, 2-2116, 2032, 1971, 2081, 1946, 1945. When these ECO's have been incorporated, re-identify the PWA as 1001194-0* REV B. Stamp or mark on the solder side of the board ECO's 2-4782, 2-2920, 2-2365, 2-2210, 2-2116, 2032, 1971, 2082, 1946, 1945.

- 1001194-01, 02, 03 REV 13 will require ECO's 2-4782, 2-2920, 2-2365, 2-2210, 2-2116, 2032, 1971, 2082, 1946. When these ECO's have been incorporated, re-identify the PWA as 1001194-0*-REV B. Stamp or mark on the solder side of the board ECO's 2-4782, 2-2920, 2-2365, 2-2210, 2-2116, 2032, 1971, 2082, 1946.
- 1001194-01, 02, 03 REV 14 will require ECO's 2-4782, 2-2920, 2-2365, 2-2210, 2-2116, 2032, 1971, 2082. When these ECO's have been incorporated re-identify the PWA as 1001194-0* REV B. Stamp or mark on the solder side of the board ECO's 2-4782, 2-2920, 2-2365, 2-2210, 2031, 1971, 2082.
- 1001194-01, 02, 03 REV 15 will require ECO's 2-4782, 2-2920, 2-2365, 2-2210, 2-2116, 2032. When these ECO's are incorporated, re-identify the PWA as 1001194-0* REV B. Stamp or mark on the solder side of the board ECO's 2-4782, 2920, 2-2365, 2210, 2-2116, 2032.
- 1001194-01, 02, 03 REV 16 will require ECO's 2-4782, 2-2920, 2-2365, 2210, 2-2116. When these ECO's have been incorporated, re-identify the PWA's as 1001194-0* REV B. Stamp or mark on the solder side of the board, ECO's 2-4782, 2-2920, 2-2365, 2-2210, 2-2116.
- 1001194-01, 02, 03 REV 17 will require ECO's 2-4782, 2-2920, 2-2365, 2210. When these ECO's have been incorporated, re-identify the PWA's as 1001194-0* REV B. Stamp or mark on the solder side of the board, ECO's 2-4782, 2-2920, 2-2365, 2-2210.
- 1001194-01, 02, 03 REV 18 will require ECO's 2-4782, 2-2920, 2-2365. When these ECO's have been incorporated, re-identify the PWA as 1001194-0* REV B. Stamp or mark on the solder side of the board, ECO 2-4782; 2-2920, 2-2365.
- 1001194-01, 02, 03 REV 19 will require ECO's 2-4782, 2-2920. When these ECO's have been incorporated, re-identify the PWA as 1001194-0* REV B. Stamp or mark on the solder side of the board, ECO 2-4782, 2-2920.
- 1001194-01, 02, 03 REV A and 20 will require ECO's 2-4782. When this ECO has been incorporated, re-identify the PWA as 1001194-0* REV B. Stamp or mark on the solder side of the board ECO 2-4782.

* When all ECO's have been incorporated re-identify PWA's as:

1001194-01 up dated to 1001194-04
1001194-02 up dated to 1001194-05
1001194-03 up dated to 1001194-06

*** All 1001194 boards must have the 20 bit address modification added before the boards may be shipped. This FIX will allow all IPB's to be interchangeable. An ECO is being written to correct this problem.

SEE ATTACHED DETAILS ON EACH ECO

ECO 1945

Add .22 uh choke to clock service line

1. Clip pin A79-8 flush with PCB and bend up pin.
2. Solder choke .22 uh (101808-003) from A79-8 to adjacent jumper wire as shown in below.

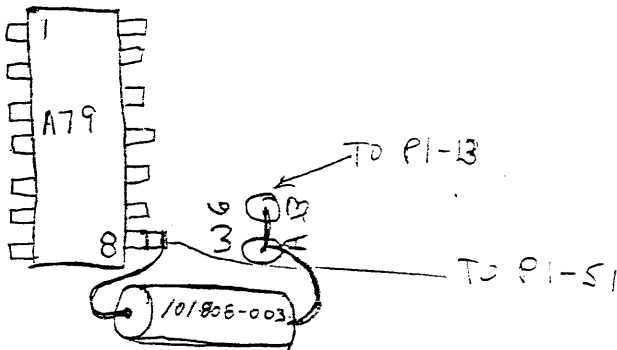

ECO 1946

Manufacturing change - add sockets to
parts list

No rework

REWORK INSTRUCTIONS

ECO 1971 and ECO 2982

1. Remove EPROM 2716 at A48 and A57.
2. Replace EPROMS with new EPROM
 - A. 101638-001 at A48
 - B. 101639-001 at A57

ECO 2032

Parts list change - No rework

ECO 2-2116

Parts list change - No rework

REWORK INSTRUCTIONS

ECO 2210

1. Replace all 74S74 (100913-001) with 74LS74 (100914-001)
2. Cut trace from A9-15 to A26-11
3. Add jumpers as follows, (see figure 1):

<u>FROM</u>	<u>TO</u>
A27-19	A44-9
A9-15	A44-10 & 11
A44-8	A52-12 & 13
A52-11	A26-11

FIGURE 1

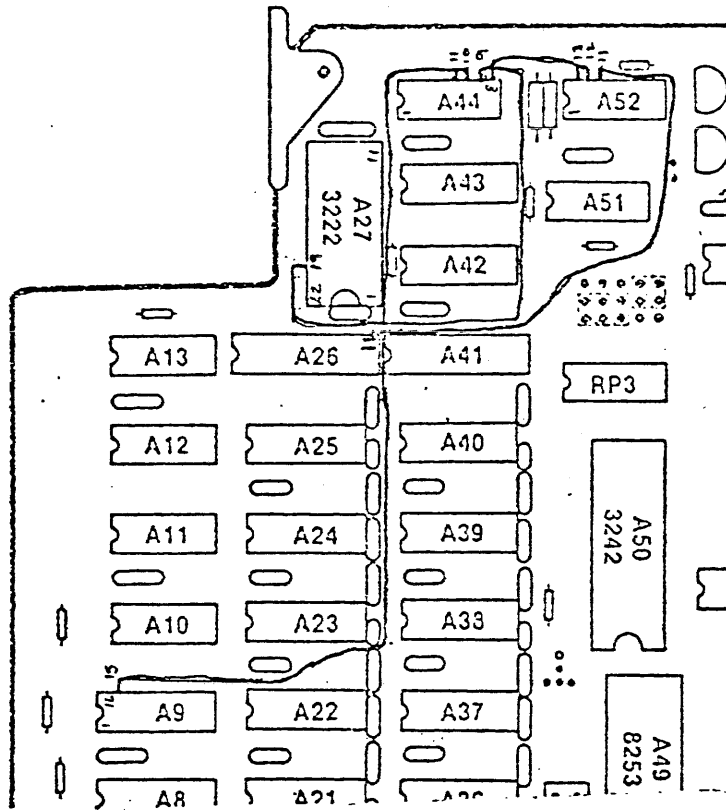

ROUTING FOR ECO 2210

ECO 2-2365

Manufacturing change - change drawing for VRI

Hardware - no rework

REWORK INSTRUCTIONS

ECO 2-2920

1. Remove 0.02 uf CAP from C4-0 (P/N 101764-087).
2. Remove 180 K ohm RES from R10 (P/N 101655-048).
3. Add 0.1 uf CAP (Item 115, P/N 64-050) at C40.
4. Add 33 K ohm RES (Item 74 P/N 101655-091) at R10.

REWORK INSTRUCTIONS

ECO 2-4782

1. Replace IC 52-789 at location A70 with IC 9110299
2. Remove A54 pin 2 from pad on the board and bend the lead straight out from body of IC as shown below:

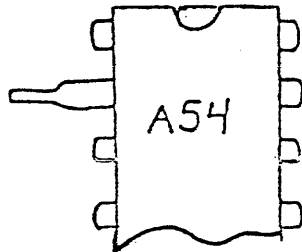

3. On solder side, cut trace running from RP8-3 to the feed thru located near A84-9
4. On component side, add a jumper from the feed thru located below and to the right of A84-9 to A70-12
5. On component side, add a jumper from lead of A54-2 to A47-2
6. Replace the inductor at L1 μ .22 uh with an inductor μ h (P/N 50-003)

20 BIT ADDRESS PIGGY-BACK BOARD

P/N 1002234-01

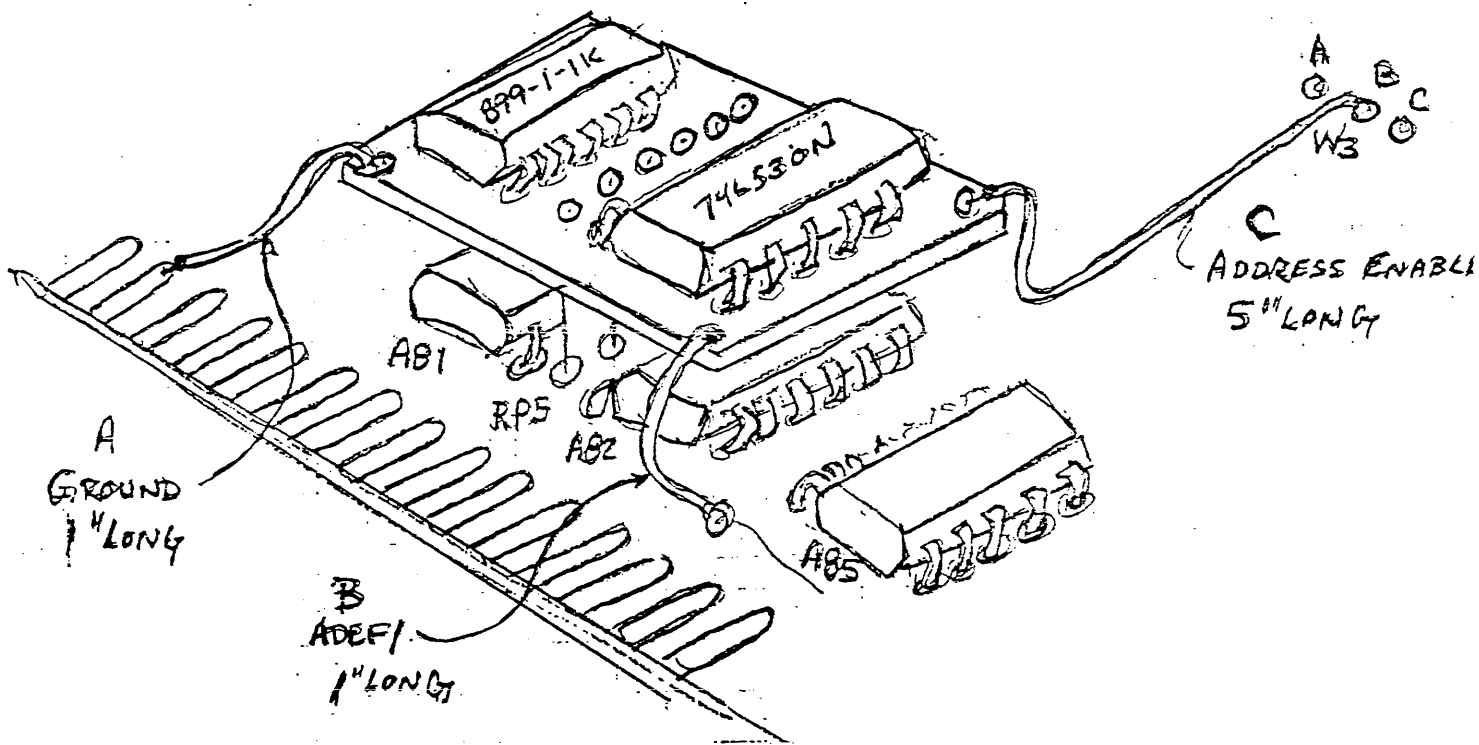

INSTALLATION PROCEDURE:

1. Remove RP5, A SIP resistor package
2. Fit prongs of piggy-back board into holes of RP5 and solder
3. Solder Jumper A to ground
4. Solder Jumper B to ADRF/ at feed through
5. Solder Jumper C to jumper feed through W3-B

IOC 4 LAYER

<u>P/N DASH</u>	<u>REV LEVEL</u>	<u>ECO REQUIRED</u>
1002104-04	M	NONE
1002104-04	L	13-5895
1002104-04	K	13-5900, 13-5895
1002104-04	J	13-5824, 13-5900, 13-5895
1002104-04	H	13-5552, 13-5824, 13-5900, 13-5895
1002104-04	G	2-5177, 13-5552, 13-5824, 13-5900, 13-5895
1002104-03	F	2-5304, 2-5177, 13-5552, 13-5824, 13-5900, 13-5895
1002104-03	E	2-5304, 2-5060, 2-5177, 13-5552, 13-5824, 13-5900, 13-5895
1002104-03	D	2-5304, 2-5060, 2-5107, 2-5177, 13-5552, 13-5824, 13-5900, 13-5895
1002104-02	C	2-5304, 2-5060, 2-5107, 2-4620, 2-5177, 13-5552, 13-5824, 13-5900, 13-5895
1002104-02	B	2-5304, 2-5060, 2-5107, 2-4620, 2-4565, 2-5177, 13-5552, 13-5824, 13-5900, 13-5895
1002104-01	A	2-5304, 2-5060, 2-5107, 2-4620, 2-4565, 2-3629, 2-5177, 13-5552, 13-5824, 13-5900, 13-5895

Scrap 1002104-01 REV 2 and below.

ECO 2-3629	Upgrade 2169, GND A72, pin 7
ECO 2-4565	Change IC socket to more reliable type
ECO 2-4620	Remove floppy controller chip 8271 (no rework)
ECO 2-5107	Add missing jumper plug to wire list (no rework)
ECO 2-5060	Add jumper to wire list (no rework)
ECO 2-5304	Upgrade bias for beeper circuit
ECO 2-5177	Parts list change - no rework
ECO 13-5552	Parts list change - no rework

ECO 13-5824 Parts list change - no rework
ECO 13-5900 Manufacturing change - no field rework
ECO 13-5895 Parts list change - no rework

- All 1003104 which are shipped must be the latest DASH and REV level or reworked to the latest DASH and REV level.
- 1002104-01 REV A will require ECO's 2-5304, 2-5060, 2-4620, 2-4564, 2-3629. When these ECO's are incorporated, re-identify PWA as 1002104-04 REV M. Stamp or mark the solder side of the board with ECO 2-5304, 2-5060, 2-5107, 2-4620, 2-4565, 2-3629, 2-5177, 13-5552, 13-5824, 13-5900, 13-5895.
- 1002104-02 REV B will require ECO's 2-5304, 2-5060, 2-5107, 2-4620, 2-4565. When these ECO's have been incorporated, re-identify PWA as 1002104-04 REV M. Stamp or mark the solder side of the board with ECO 2-5304, 2-5060, 2-5107, 2-4620, 2-5177, 13-5824, 13-5900, 13-5895.
- 1002104-02 REV C will require ECO's 2-5304, 2-5060, 2-5107, 2-4620. When these ECO's have been incorporated, re-identify PWA as 1002104-04 REV M. Stamp or mark the solder side of the board with ECO's 2-5304, 2-5060, 2-5107, 2-4620, 2-5177, 13-5552, 13-5824, 13-5900, 13-5895.
- 1002104-03 REV D will require ECO's 2-5304, 2-5060, and 2-5107. When these ECO's have been incorporated, re-identify PWA as 1002104-04 REV M. Stamp or mark the solder side of the board with ECO's 2-5304, 2-5060, 2-5107, 2-5177, 13-5552, 13-5824, 13-5900, 13-5895.
- 1002104-03 REV E will require ECO's 2-5304 and 2-5060. When these ECO's have been incorporated, re-identify the PWA as 1002104-04 REV M. Stamp or mark the solder side of the board with ECO 2-5304, 2-5060, 2-5177, 13-5552, 13-5824, 13-5900, 13-5895.
- 1002104-03 REV F will require ECO 2-5304. When this ECO has been incorporated re-identify the PWA as 1002104-04 REV M. Stamp or mark solder side of the board with ECO 2-5304, 2-5177, 13-5552, 13-5824, 13-5900, 13-5895.

SEE ATTACHED DETAILS ON EACH ECO

REWORK INSTRUCTIONS

ECO 2-4565

1. Remove 40 pin IC's at locations A1, A20, A58, A69 and A72.
2. Inspect 40 pin sockets for the type shown below:
The 40-pin sockets to be replaced are Intel P/N 68-234 (typical example shown below)

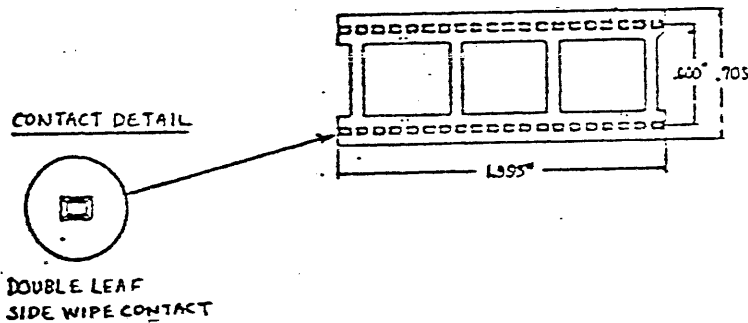

Typical manufacturers are: Robinson-Nugent (example above)
SAE
Burndy

3. If PWA does not have this type of socket, replace IC's in sockets (sockets are then of the right type).
4. If PWA does have the above sockets, remove all 40-pin sockets shown above.
5. Replace 40-pin sockets with Scanbe or Augat type (P/N 102989-00 or 101581-040)
6. Replace IC's in sockets

REWORK INSTRUCTIONS

ECO 2-3629

1. Cut trace running to A55-13, from feed thru

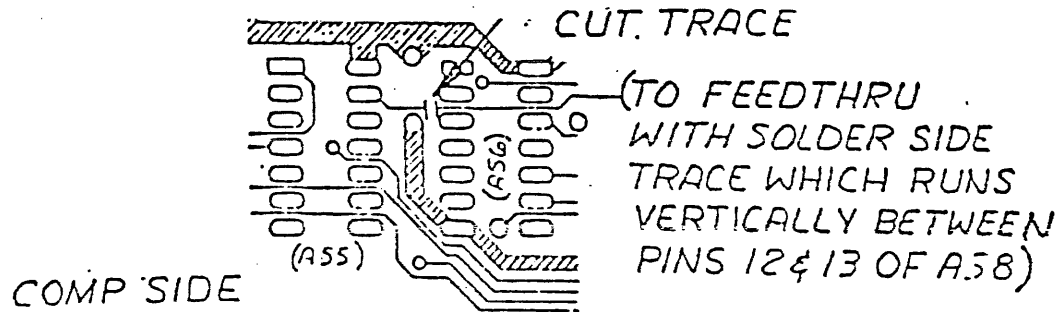

2. Add jumper wire from feed thru just cut to A56-2
3. Add jumper from A72-7 to A72-20 (GND)

REWORK INSTRUCTIONS

ECO 2-5304

1. Remove resistor R41 (1K 5% $\frac{1}{4}W$) and replace with:
(1ea) 101656-06Z resistor 750 $\frac{1}{4}W$ 5%.
2. Add (1ea) capacitor P/N 101754-049, CER. 0.1 UF 50V. Between A56-7 (gnd)
and R41, per sketch below. (Sleeve leads as shown)

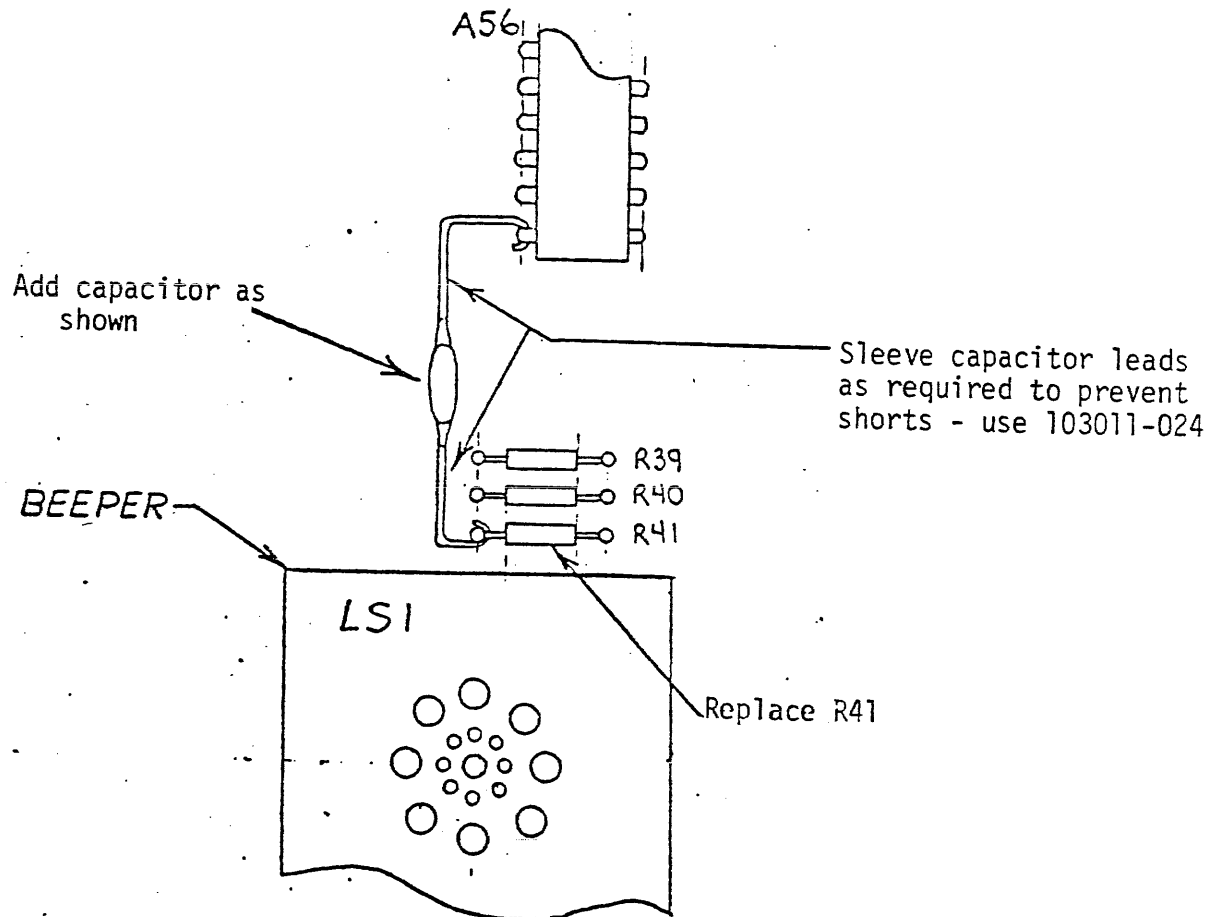

IOC 2 LAYER

<u>P/N</u>	<u>DASH</u>	<u>REV</u>	<u>ECO REQUIRED</u>
1001241-07		D	None
1001241-06		C	5638
1001241-06		B	5638, 2-4578
1001241-05		A	5638, 2-4578, 2-3774
1001241-05		21	5638, 2-4578, 2-3774
1001241-04		20	5638, 2-4578, 2-3774, 2-2699A
1001241-04		19	5638, 2-4578, 2-3774, 2-2699A, 1982
1001241-04		18	5638, 2-4578, 2-3774, 2-2699A, 1982, 1970
1001241-04		17	5638, 2-4578, 2-3774, 2-2699A, 1982, 1970, 1876
1001241-04		16	5638, 2-4578, 2-3774, 2-2699A, 1982 1970, 1876, 1635-3
1001241-04		15	5638, 2-4578, 2-3774, 2-2699A, 1982, 1970, 1876, 1635-3, 1802
1001241-04		14	5638, 2-4578, 2-3774, 2-2699A, 1982 1970, 1876, 1635-3, 1802, 1711
1001241-04		13 and below	Scrap

ECO 5638	Add (12) 20 ga jumper wire to reduce noise and improve (ESD)
ECO 2-4578	Change IC Sockets to more reliable type
ECO 2-3774	Gnd pin 7 of 8041
ECO 2-2699A	Add cap C90, 470 ohm Resistor, RAE chip sel
ECO 1982	Allow use of 2109 instead of 2108 (manufacturing only, no field work)
ECO 1970	Change A72 8741 from 9100086 to 9100123 (101640-001)
ECO 1856	Drawing change, no rework
ECO 1635-3	Change parts list
ECO 1802	Change 2716 from 9100087 to 9100102 (101608-001)
ECO 1711	Change A72 from 910034 to 910086 (disregard up-date in ECO 1970)

- All 1001241's which are shipped must be the latest dash and REV level or reworked to the latest dash or REV level.
- 1001241 REV 14 will require ECO 5638, 2-4578, 2-3774, 2-2699A, 1982, 1970, 1876, 1635-3, 1802, 1711. When these ECO's are incorporated, re-identify the PWA as 1001241-06 REV C. Stamp or mark on the solder side of the board, ECO 5638, 2-4578, 2-3774, 2-2699A, 1982, 1970, 1876, 1635-3, 1802, 1711.
- 1001241 REV 15 will require ECO's 5638, 2-4578, 2-3774, 2-2699A, 1982, 1970, 1876, 1635-3, 1802. When these ECO's have been incorporated, re-identify the PWA as 1001241-06 REV C. Stamp or mark on the solder side of the board, ECO 5638, 2-4578, 2-3774, 2-2699A, 1982, 1970, 1876, 1635-3, 1802.
- 1001241 REV 16 will require ECO's 5638, 2-4578, 2-3774, 2-2699A, 1982, 1970, 1876, 1635-3. When these ECO's have been incorporated, re-identify the PWA as 1001241-06 REV C. Stamp or mark on the solder side of the board, ECO 5638, 2-4578, 2-3774, 2-2699A, 1982, 1970, 1876, 1635-3.
- 1001241 REV 17 will require ECO's 5638, 2-4578, 2-3774, 2-2699A, 1982, 1970, 1876. When these ECO's have been incorporated, re-identify the PWA as 1001241-06 REV C. Stamp or mark on the solder side of the board ECO, 5638, 2-4578, 2-3775, 2-2699A, 1982, 1970, 1876.
- 1001241 REV 18 will require ECO's 5638, 2-4578, 2-3774, 2-2699A, 1982, 1970. When these ECO's have been incorporated, re-identify the PWA as 1001241-06 REV C. Stamp or mark on the solder side of the board ECO 5638, 2-4578, 2-3774, 2-2699A, 1982, 1970.
- 1001241 REV 19 will require ECO's 5638, 2-4578, 2-3774, 2-2699A, 1982. When these ECO's have been incorporated, re-identify the PWA as 1001241-06 REV C. Stamp or mark on the solder side of the board ECO 5638, 2-4578, 2-3774, 2-2699A, 1982.
- All 1001241's which are shipped must be the latest dash and REV level or reworked to the latest dash or REV level.
- 1001241-04 REV 20 will require ECO's 2-4578, 2-3774, and 2-2699A. When these ECO's are incorporated, re-identify the PWA as 1001241-06 REV C. Stamp or mark on the solder side of the board, ECO 2-4578, 2-3774, 2-2699A.
- 1001241-05 REV 21 and REV A must be reworked with ECO 2-4578, 2-3774. When these ECO's have been incorporated, re-identify the PWA as 1001241-06 REV C. Stamp or mark on the solder side of the board, ECO 2-4578.
- 1001241-06 REV B must be reworked with ECO 2-4578. When this ECO is incorporated, re-identify the PWA as 1001241-06 REV C. Stamp or mark on the solder side of the board, ECO 2-4578.
- 1001241-07 REV C must be reworked with ECO 5638. When this ECO has been incorporated, re-identify the PWA as 1001241-07 REV D. Stamp or mark on the solder side of the board ECO 5638.

ECO 2-5177

Parts list change - no rework

ECO 13-5552

Parts list change - no rework

ECO 13-5824

Parts list change - no rework

ECO 13-5900

Manufacturing change - no field rework
Add 14 pin socket to IOC at location Y1

ECO 13-5895

Parts list change - no rework
Firmware change for reset of UPP

ECO 1711

Change A72 from 9100034 to 9100086. Disregard
this ECO - A72 is up dated in ECO 1970.

ECO 1802

Change 2716 at A50 from 9100087 to 9100102 (101608-001)

ECO 1635-3

Parts list change, no rework

ECO 1856

Drawing change, no rework

ECO 1970

Change A72 8741 from 9100086 to 9100123 (101640-001)

ECO 1982

Use as is in field, manufacturing change.
Replace 2108 RAM memory A30-33, A41-44 with 2109 RAM
chips (101048-008)
This is an optional change, no field rework is required.
See ECO for rework if needed.

REWORK INSTRUCTIONS

ECO 2-2699A

1. Cut trace (solder side) at A49-8.
2. Cut trace (solder side) between A17-3 and A17-4.
3. Cut trace (component side) A2-10 to feed through.
4. Cut trace emerging from under A34 (comp. side) between pins.
5. Add jumper from A49-10 to A84-1 (component side)
6. Add jumper from A34-1 to feed through adjacent to A36-5 (component side)
7. Add jumper from A17-1 to A17-3 (component side)
8. Add jumper from feed through adjacent to A2-10 to A2-12 (component side)
9. Add jumper from A6-11 to J18-16 (solder side)
10. Add jumper from A6-12 & 13 to A1-39 (solder side)
11. Add (1 ea.) 470 Ω resistor (P/N 101656-022) from A68-6 to A68-16 (component side)
12. Add capacitor C-90 in parallel to resistor R1. P/N 101766-037 CAP. CER, .01 μ F +80, -20% 25V.

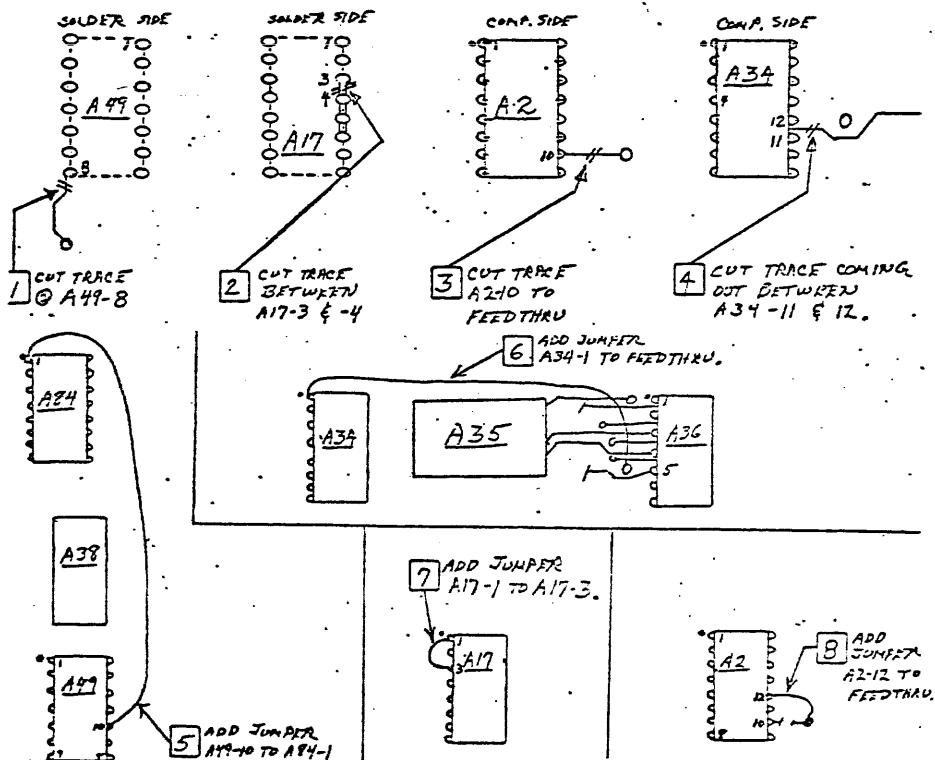

REWORK INSTRUCTIONS
 ECO 2-2699A (continued)

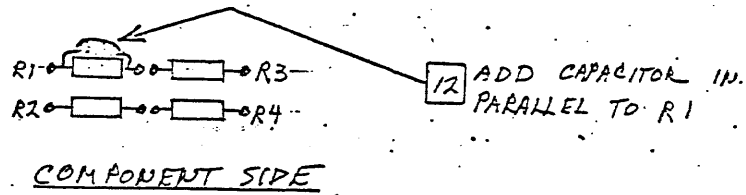
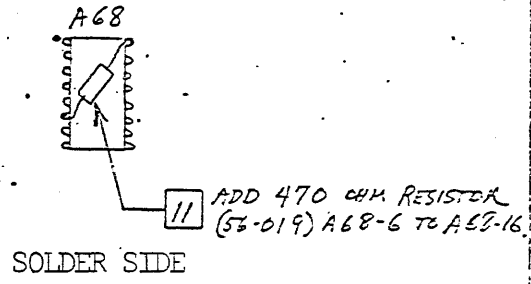
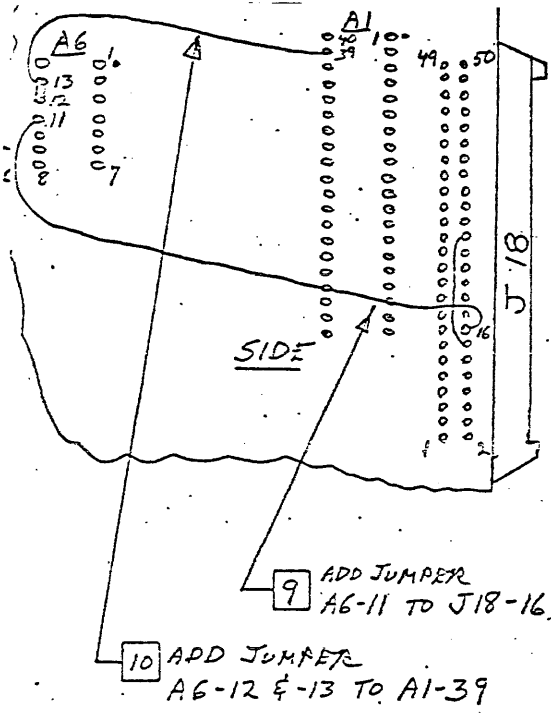

REWORK INSTRUCTIONS

ECO 2-3774

1. Add jumper from A72-7 to A72-20 (gnd) or equivalent

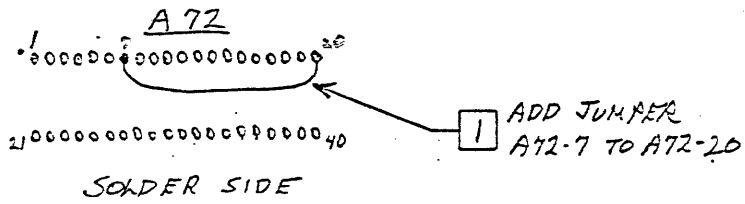

REWORK INSTRUCTIONS

ECO 2-4578

1. Remove 40 pin IC's at locations A1 (8271), A20 (8275), A58 (8257), A69 (8080A-2), and A72 (8741-4).
2. Inspect 40 pin sockets for the type shown below:

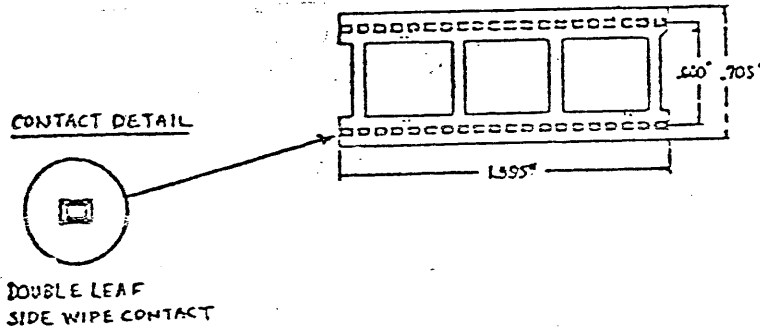

If PWA does not have this type of socket, replace IC's in sockets (sockets are the correct type).

3. If PWA does have the above sockets, remove all 40-pin sockets shown above.
4. Replace 40 pin sockets with Intel P/N 102989-001.
5. Replace IC's in sockets.

REWORK INSTRUCTIONS

ECO 13-5638

1. Add 12 jumpers using 20AWG green stranded wire per the following:

1.1 Solder Side

1.1.1 From A4-8 to A19-12 (gnd)

1.1.2 From feedthru in gnd bus between A33-16 and A6-7 to lead of C23 adjacent to A34-15.

1.1.3 From feedthru adjacent to C87 and A78-16 to A76-1.

(SEE FIGURE 1)

FIGURE 1

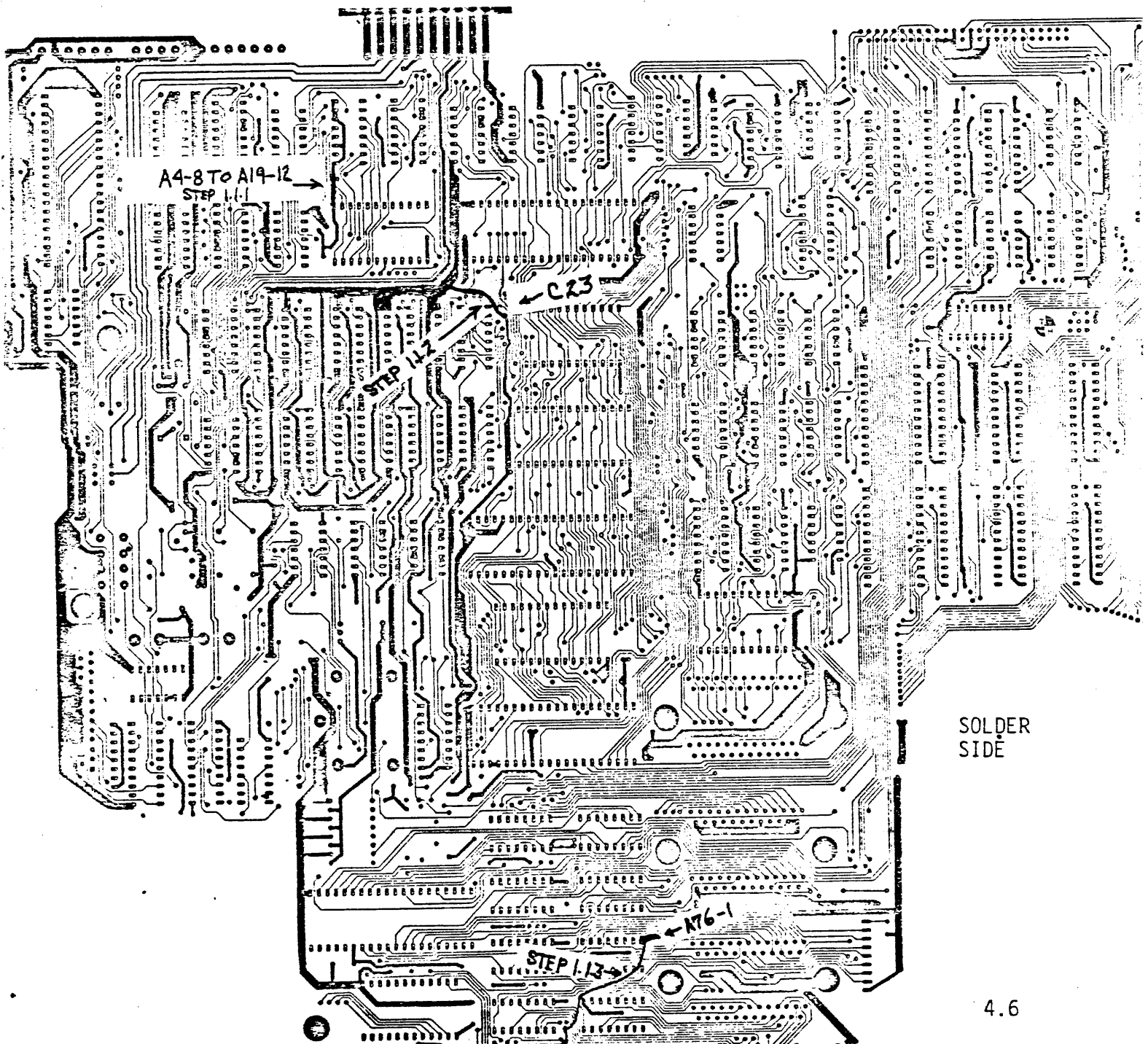

REWORK INSTRUCTIONS
ECO 13-5638 (continued)

1.2 Component Side

1.2.1 From feedthru of gnd bus near large hole between J2 & J3 and near the edge of board to A62-12

1.2.2 From gnd bus near A71-16 to C78 lead beside A69-29

1.2.3 From double feedthru on gnd bus beside A66-28 to A67-12

(SEE FIGURE 2)

FIGURE 2

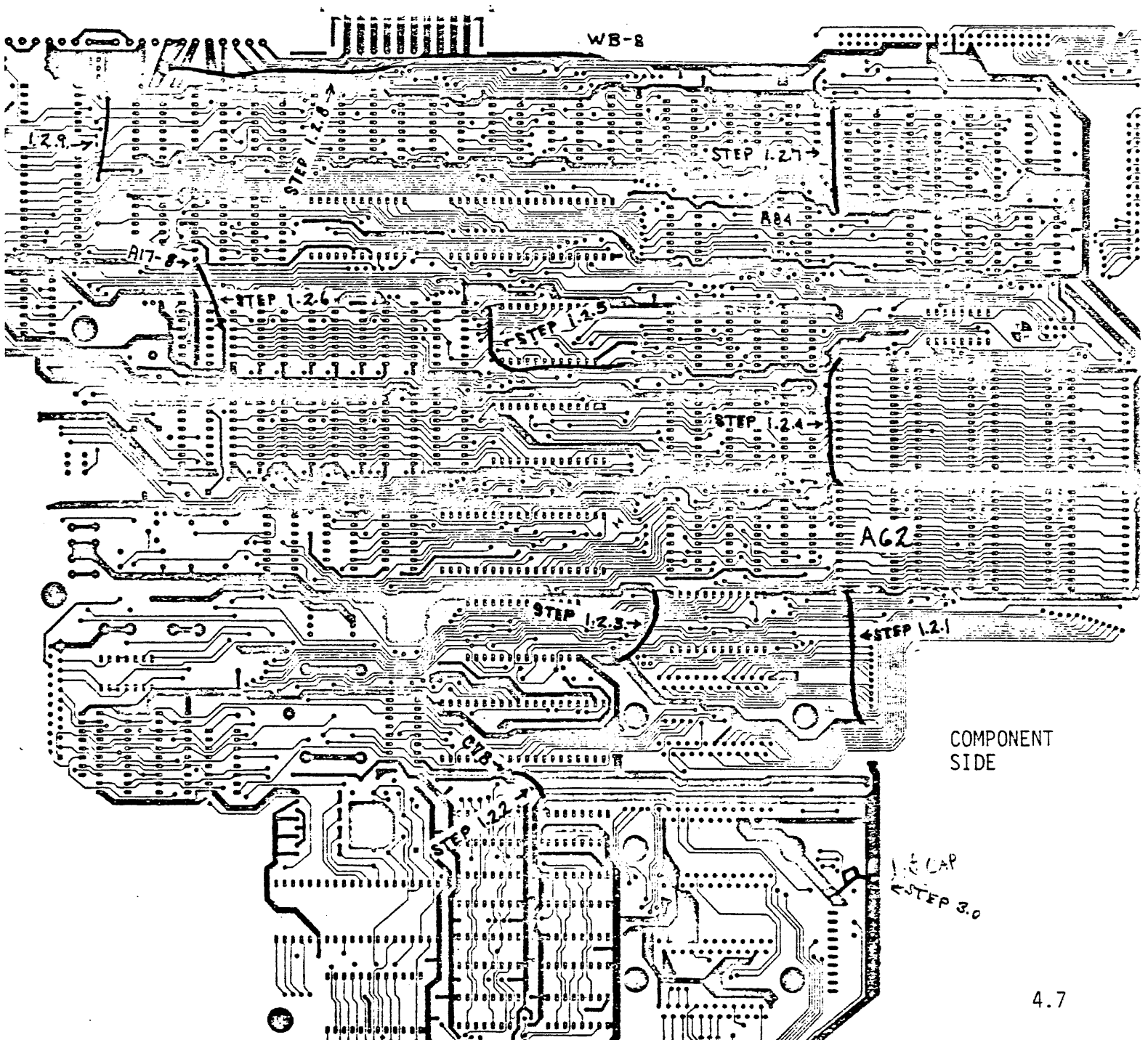

REWORK INSTRUCTIONS
ECO 13-5638 (continued)

- 1.2.4 From bus at lead of R37 to double feedthru near A50-1.
 - 1.2.5 From bus running under body of R26 at C24 lead to bus connecting C23 and A35-12.
 - 1.2.6 From bus at lead of C19 (going to C28) to A17-8.
 - 1.2.7 From gnd bus between A84-16 and C16 to heavy gnd bus at C8.
 - 1.2.8 From gnd bus at W8-B to double feedthru beside R6 single pad (bus running to J16 - 5 & 6).
 - 1.2.9 From bus between R10 & R11 to gnd plane at R6.
- 3.0 Solder $1\mu\text{F}$ capacitor 101754-061 from chassis gnd to logic gnd by R53.
(SEE FIGURE 3)

FIGURE 3

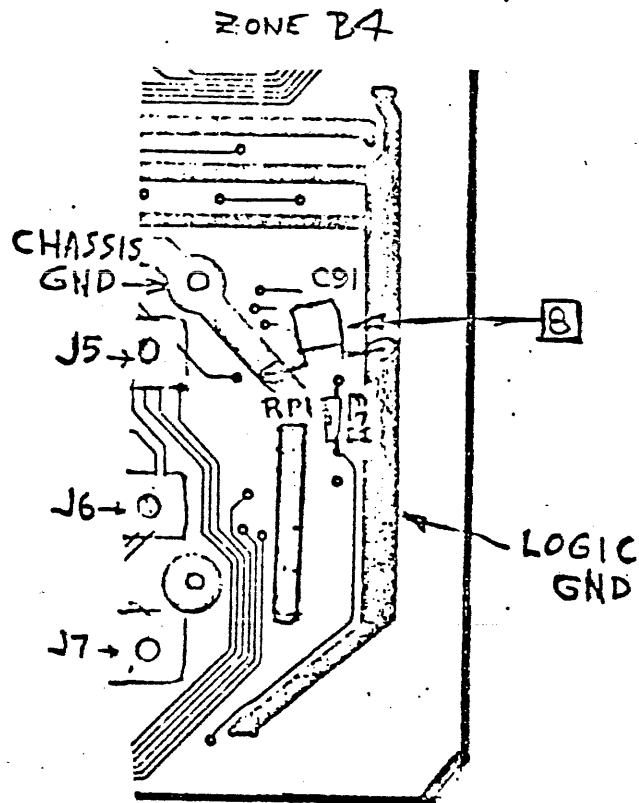

REWORK INSTRUCTIONS
 ECO 13-5638 (continued)

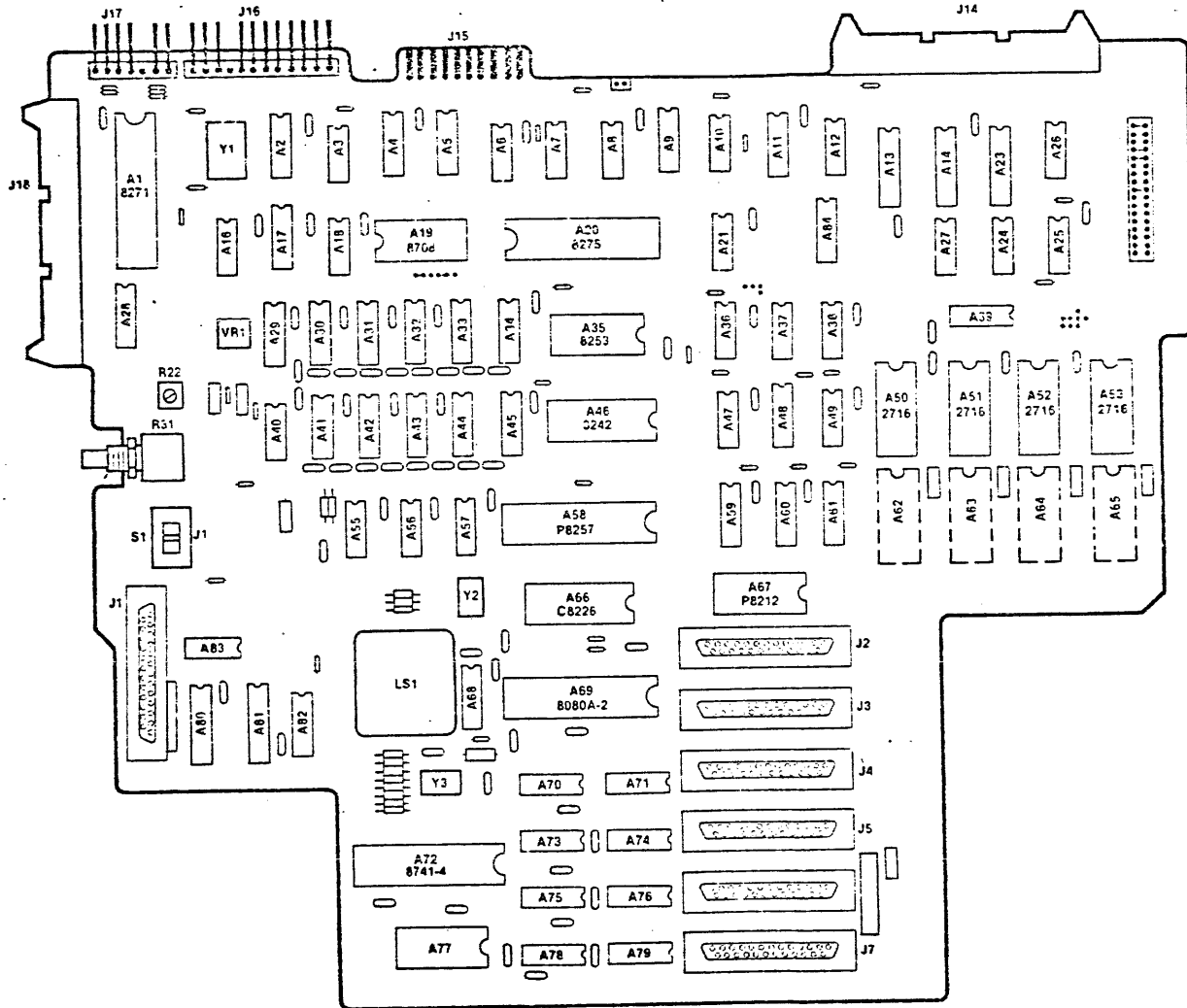

DDR INTERFACE BOARD

<u>P/N</u>	<u>DASH</u>	<u>REV LEVEL</u>	<u>ECO REQUIRED</u>
1001036-04		N	None
1001036-03		M	13-5736
1001036-03		L	2-5048, 13-5736
1001036-03		K	4549, 2-5048, 13-5736
1001036-02		J	4549, 4494, 2-5048, 13-5736
1001036-02		H	4549, 4494, 3841, 2-5048, 13-5736
1001036-02		D-G	4549, 4494, 3841, 3057, 12-5048, 12-5048, 13-5736
1001036-01		C	4549, 4494, 3841, 3057, 1805, 2-5048, 13-5736
1001036-01		A-B	4549, 4494, 3841, 3057, 1805, 2-5048, 13-5736

ECO 1805 - Allow for higher noise immunity when using RMX

ECO 3057 - Insulate voltage regulator from P.C. board

ECO 3841 - Change W2 voltage strap for -12 V to -10 V

ECO 4494 - Change trip pot R13 to 1K

ECO 4549 - Change Xtal socket to M029 reliable type

ECO 2-5048 - Parts list change - no rework

ECO 13-5736 - Correct noise problem and adjust PLL range.

-- All 1001036's which are shipped must be the latest dash and REV level or reworked to the latest dash or REV level.

-- 1001036-01 REV A, B, or C must be reworked with ECO's 4549, 4494, 3841, 3057, 1805, 2-5048 and 13-5736. When these ECO's have been incorporated, re-identify the PWA as 1001036-04 REV N. Stamp or mark on the solder side of the board, ECO 4549, 4494, 3841, 3057, 1805, 2-5048, and 13-5736.

-- 1001036-02 REV D-G must be reworked with ECO's 4549, 4494, 3841, 3057, 2-5048, and 13-5736. When these ECO's have been incorporated, re-identify the PWA as 1001036-04 REV N. Mark or stamp the solder side of the board with ECO's 4549, 4494, 3841, 3057, 2-5048, and 13-5736.

- 1001036-02 REV H must be reworked with ECO's 4549, 4494, 3841, 2-5048 and 13-5736. When these ECO's have been incorporated, re-identify the PWA as 1001036-04 REV N. Mark or stamp the solder side of the board with ECO's 4549, 4494, 2-5048, and 13-5736.
- 1001036-03 REV K must be reworked with ECO 4549, 2-5048, and 13-5736. When ECO 4549, 2-5048, and 13-5736 have been incorporated, re-identify the PWA as 1001036-04 REV N. Stamp or mark on the solder side of the board ECO 4549, 2-5048, and 13-5736.
- 1001036-03 REV L must be reworked with ECO's 2-5048 and 13-5736. When these ECO's have been incorporated, re-identify the PWA as 1001036-04 REV N. Stamp or mark on the solder side of the board ECO 2-5048 and 13-5736.
- 1001036-03 REV M must be reworked with ECO 13-5736. When this ECO has been incorporated, re-identify the PWA as 1001036-04 REV N. Stamp or mark on the solder side of the board ECO 13-5736.

REWORK INSTRUCTIONS

ECO 1805

1. Remove Pin 3 A55 from the board and cut the pin off as close to the body of the IC as possible.
2. Add a wire from A30 Pin 1 to A55 Pin 2 using 22 gauge wire.
3. Add a wire from A30 Pin 2 to the pad where A55 Pin 3 was formerly located.
4. Epoxy at point shown in figure below:

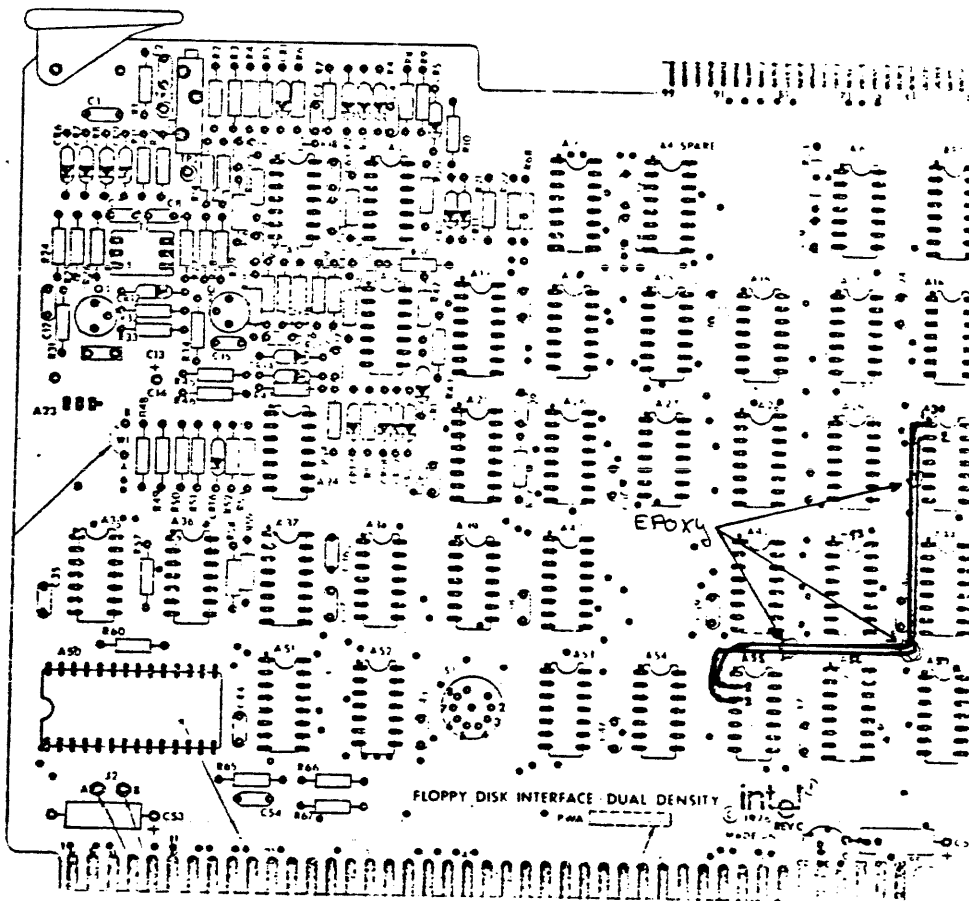

REWORK INSTRUCTIONS

ECO 2-3057

Regulator heat sink touches solder mask, causing traces underneath to short to heat sink.

1. Lift voltage regulator at A23.
2. Place a piece of insulating tape beneath heat sink.
3. Lower voltage regulator.

REWORK INSTRUCTIONS

ECO 3841

1. Location of jumper W2 must be changed from D to C and changed to D to E, to utilize -10V power supply in Series II.

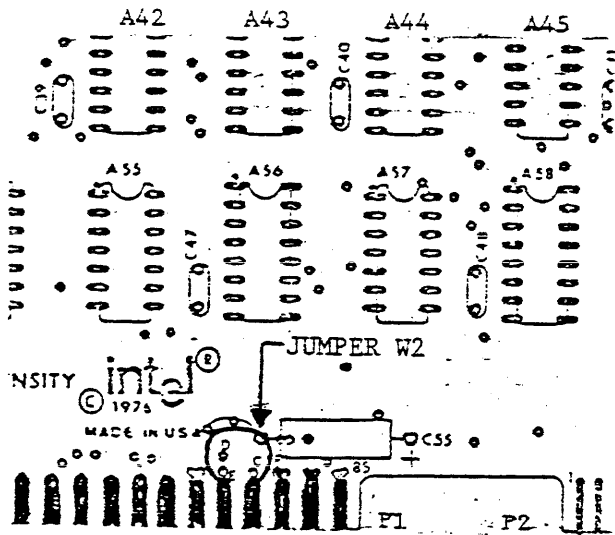

WAS:

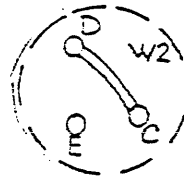

IS:

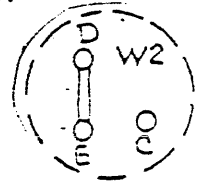

REWORK INSTRUCTIONS

ECO 2-4494

1. Remove the 5 K trim pot from locations R13.
2. Replace trim pot R13 with a 1K 10% 3/4 W. pot, P/N 101710-007.

REWORK INSTRUCTIONS

ECO 4549

1. Remove Xtal from socket
2. Remove Xtal from socket at location Y1
3. Replace Xtal socket with P/N 101564-014
4. Replace Xtal

ECO 13-5736
Rework Instructions

1.) Cut the following traces using Fig. 1 and 2 to locate the locations of each cut (*numbers inside circle indicates cut number).

*CUT NO.	FROM	TO	BOARD SIDE
1.	J1-85	A25-14	Solder
2.	J1-70	A61-14	Solder
3.	J1-72	A61-2	Solder
4.	P2-7	A37-14	Component
5.	CR-3	CR-4	Solder

Fig. 1

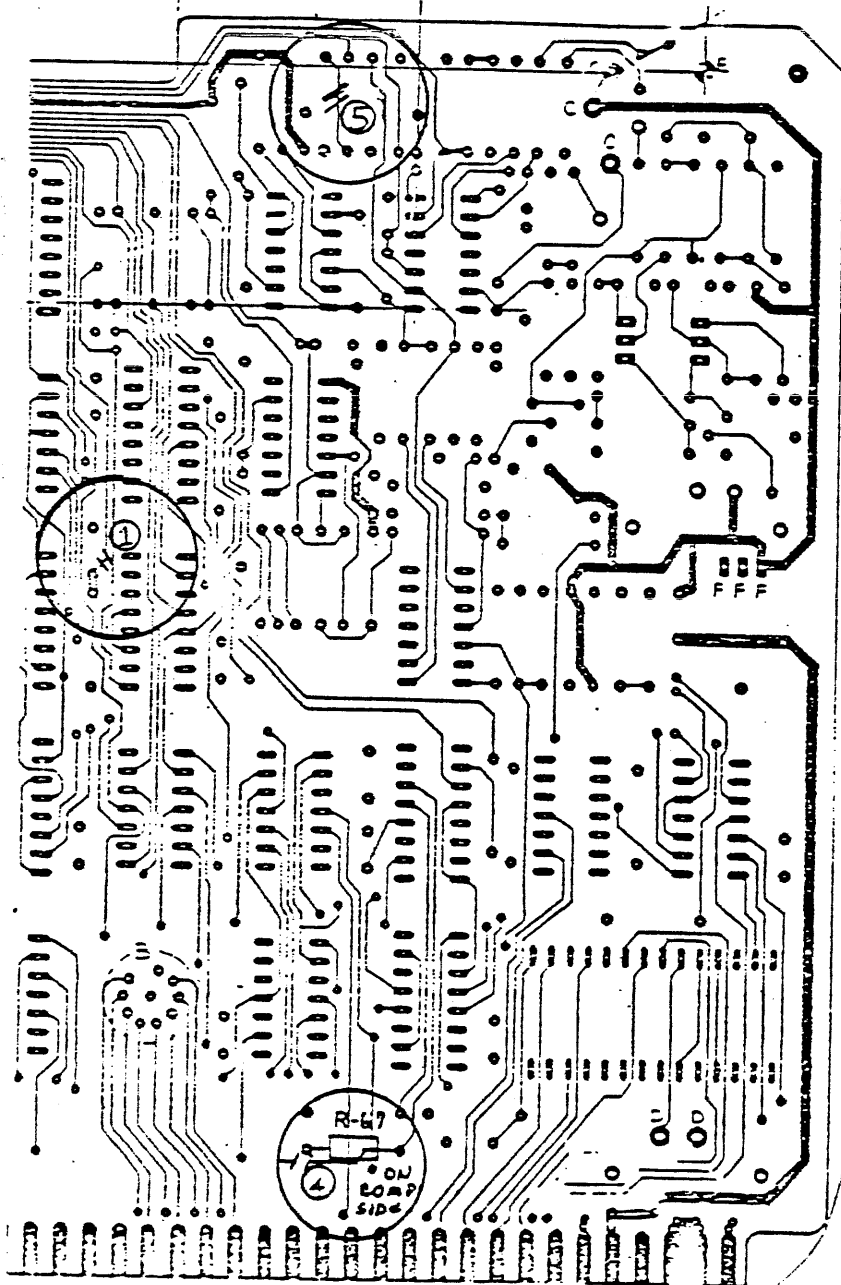
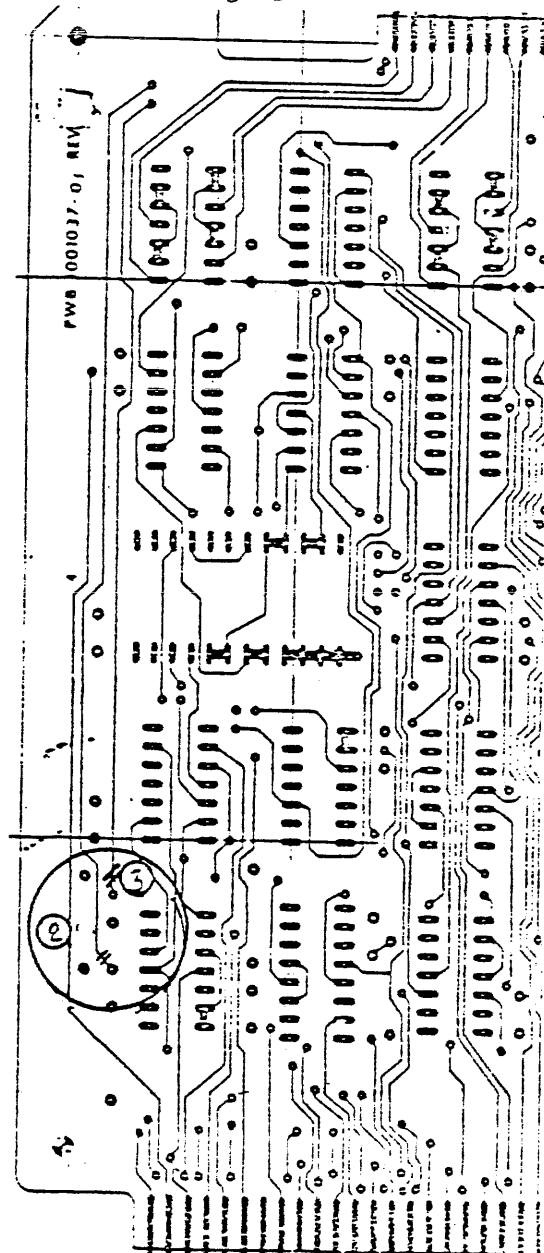

Fig. 2



2.) Add the following using Fig. 3:

Add the 15 ohm $\frac{1}{2}$ watt resistor from the cathode of CR-3 to the anode of CR-4 on the component side of the board.

Fig. 3

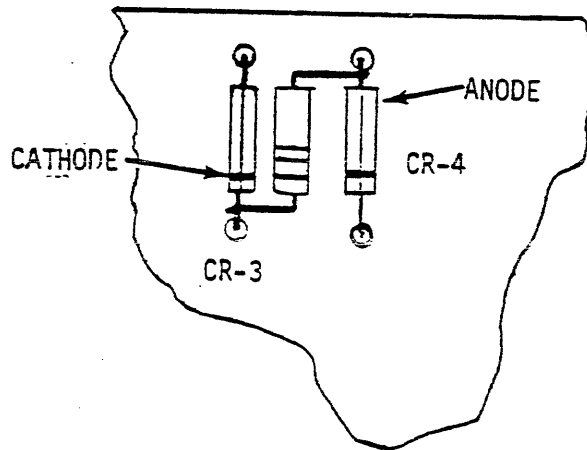

3.) Adjust freg and test board.

DDR CHANNEL BOARD

<u>P/N</u> <u>DASH</u>	<u>REV LEVEL</u>	<u>ECO'S REPAIRED</u>
1000467-05	M	
1000467-04	L	4456
1000467-02	H	4456
1000467-02	G	4456, 837

ECO 4456 - Firmware update for double density controller for compatibility with Siemens drive

ECO 839 - Tie RST pins of all 9300 IC to gnd

All DDR channel boards which are shipped must be the latest dash and REV level or reworked to the latest dash or REV level.

-- 1000467-02 REV G must be reworked with ECO's 4456, 839 when these ECO's have been incorporated, re-identify the PWA as 100467-05 REV M. Stamp or mark on the solder side of the board, ECO 4456 and 839.

SEE ATTACHED DETAILS ON EACH ECO

REWORK INSTRUCTIONS

ECO 2-4456

1. Remove IC at A11 and replace with P/N 102877-001

REWORK INSTRUCTIONS

ECO 837

1. On solder side of board, using P/N 86-018 (30 gage blue wire), jumper A37 pin 1 to A36 pin 1 to A34 pin 1 to A27 pin 1 to A29 pin 1.

IOC CHECKOUT PROCEDURE

1. Put 3-Position Slide Switch in Upper Position (Diagnostic) and Apply Power.

Note: Switch must be in position before power is applied. For this first part, nothing else is needed (i.e., CRT, Keyboard, Floppy or IPB Board). The beeper should beep 5 times — if it does, go on to Step 2. Otherwise, do one of the following, depending on how many times the beeper beeped.

1.1 The beeper didn't beep at all, or beeps with a long continuous sound. This indicates a complete malfunction, and all of the following should be checked.

- That all socketable chips are inserted, that they are the correct chips, and that no pins have been bent.
- That all voltages are present — Particularly -5 volts, which is generated on the IOC board (VRI)
- That the two main clocks are present, 22.032 MHz, with 01 and 02 (sheet 2 of schematic) and 8 MHz (Y1, sheet 3)
- That the "RST" output of 8224 is low (sheet 2), and that the "master reset" is high (sheet 2).
- That pin 13 of A81 is low (sheet 5)
- That the "HRQ" output of 8257 (sheet 2) is not stuck high.
- That the "MEMR/" of 8228 is pulsing (sheet 2)
- That the jumpers in W11 are inserted correctly (sheet 11)
- That Pin 10 of the 8253 (sheet 1) is pulsing

That is the limit of the obvious malfunctions. Assuming that the beeper works (this can be checked by grounding A83-PIN 3; See sheet 5), the problem is more subtle.

1.2 The beeper beeped once. This indicates that the problem is in the DMA area (8257, A58). Check the following

- That A49 Pin 6 is pulsing (sheet 1)
- That "HRQ" output of 8257 is pulsing PIN 10
- That "DACK1" output of 8257 is pulsing PIN 25

- That "HLDA" output of 8080A-2 is pulsing *PIN 21*

Note: These should pulse once for each 15 μ s period, at this stage.

Note: Also check that A81 PIN 13 is low. If the switch is faulty, then the IOC board thinks it's in "online" mode, where it would beep once normally.

1.3 The beeper beeped twice. This indicates that the problem is in the RAM. Remove the 8080A-2 and insert ICE-80. Try to determine which RAM chips appear bad by using the ICE-80 "fill" command. You should attempt to fill RAM alternately with FF, 00, AA, 55. The RAM resides in address space 4000 to 5FFF.

'XF M 4 T 5 U' (to map RAM unguarded)

'FI M 4000H T 5FFFH = FFH' (or 00, 55H, AAH)

G F 0 UNT 132.5 EXE TH DUMP

If just one RAM chip is bad, this will flag it for you. If all chips appear bad, then check that

- All RAM chips are of the same type (AbL or AbH, but not mixed)

- That jumper W9 is correctly configured for that type of chip

Otherwise, you'll have to scope it. Still using ICE-80,

'XF M 4 T 5 U'

'XF M 0 I 7'

'CH M 0 = 21H, 00H, 40H, 3EH, FFH, 77H, 7EH, C3H, 00H, 00H

'GO FR 0'

The statements above put a program into ICE which executes out of the MDS memory, but writes and reads from ICE RAM. The byte in address 04 (FF in the example above) should be whatever byte failed during the previous fill command.

With this program executing, sync on "MEMW/" (A5b.10, Sheet 8) and check all the RAM inputs during the write cycle - the 7 address inputs to RAM should be high using the program given (sheet 9).

To get a clean trigger on "MEMR/" to check-out the RAM chips during a read is a bit harder, because "MEMR/" pulses for other than RAM reads, too. However, you generally can tell if things are bad, even if non-RAM reads are mixed in. Check that Dout is the same as the previous Din - sometimes the outputs are marginal, not quite high enough for a plus.

1.4 The beeper beeped three times. This indicates something wrong in the CRT area. (sheet 10) check "vertical DRIVE/" and "Horizontal Drive" on CRT connector (PINS 9 and b, J15). Should be as follows:

As presently written, the diagnostic won't beep just 4 times — the fifth beep is free.

The beeper beeps five times. Kill power, attach a CRT and Keyboard, and reapply power (with switch still in upper position). A message should appear on screen. If not, check contrast pot and brightness pot, then proceed as in Section 1.4. If those signals are OK, problem is likely in logic shown on Sheet 10.

- Check 8 outputs of character generator PROM (A19).
- Check that A4.13 has pulses.
- Check that A5.6 has pulses.

If characters appear on screen, but they're garbled... check jumper W10 for 2708/2716.

- .0 The message appears legibly on screen. Hit the 4 keys as requested.
- .1 No response. Check that 3 KB outputs J1-9, J1-10, J1-11 are OK. "READ KB/" and "STATUS/DATA" should be pulsing. Verify that "KB RESET/" is not holding KB reset continually (sheet 5).
- 3.2 Incorrect response - this indicates that data lines are bad (shorted, crossed, whatever) from KB. The diagnostic should indicate which.
- 4.0 Correct Response From Keyboard - Put slide switch in local (bottom) position. Turn power off and on again. A cursor will appear at upper left. Verify that all characters look good on screen, after entering them from KB.
- 5.0 To check out the remainder of the IOC board, it is necessary to hook up to an IPB.

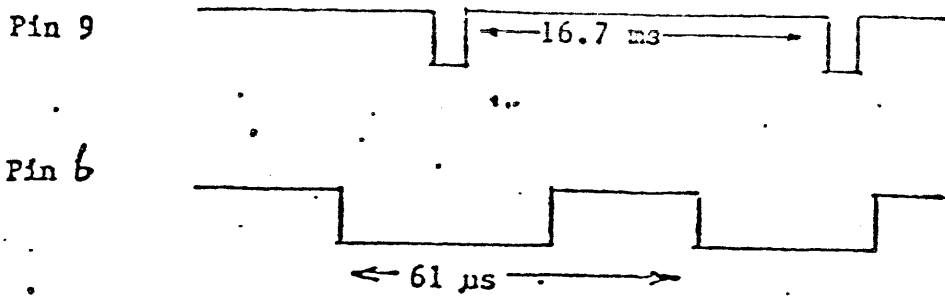

Check VRTC and HRTC on 8275. Should be:

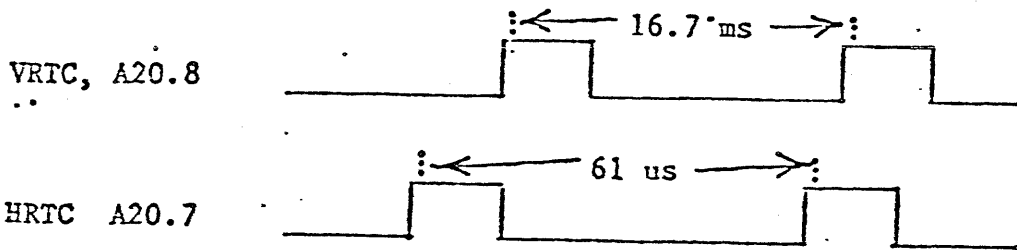

- Check "CCLK" input to 8275 A20.30
- Check "DRQ" output A20.5
- Check "DACK" input A20.6

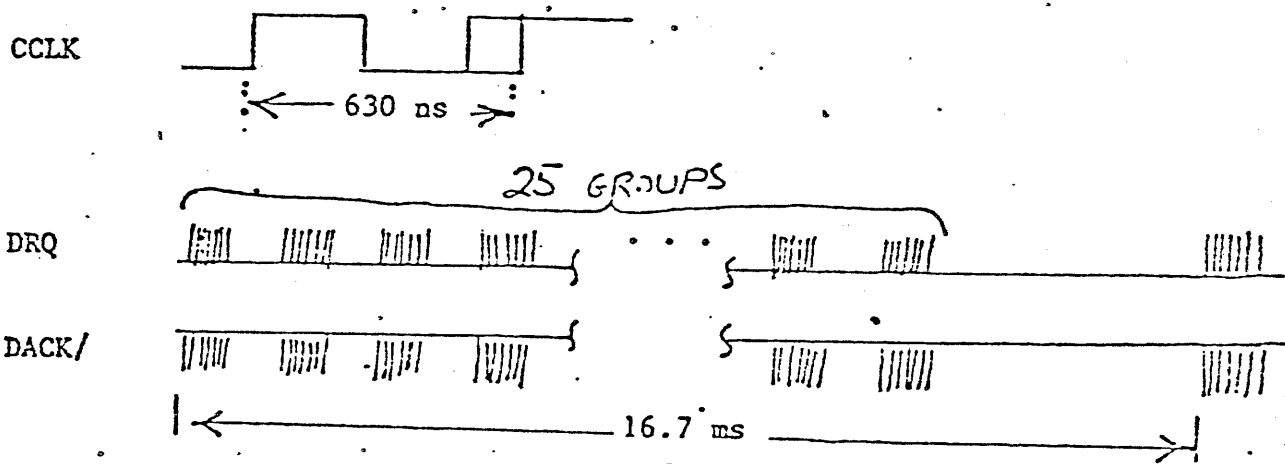

Note: If "DRQ" appears like;

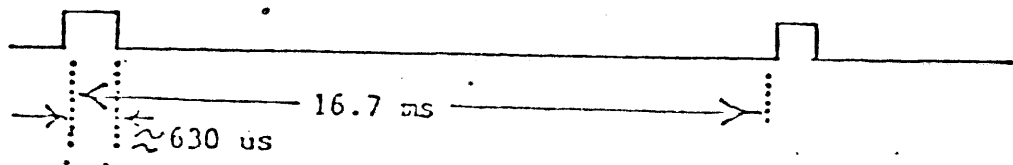

While DACK/ is always high, problem is in DMA chip (8257) area, not in 8275 area.

Is the CPU running (is the run light on) (VISIABLE INDICATION)

--if not--

- A. Do you have the processor clocks (01 and 02)
 - B. Do you have all power supply voltages on the processor (8080), +5V, +12V, -5V (If you don't have -5V volts check the -5V regulator)
 - C. If the 8224 clock generator and the 8090 are OK the 8080 is probably in a wait state constantly. That is the RDY line is never going true. If this is the case trace back through the ACK circuitry and find out what is holding the RDYIN line low. (be sure and check ADEN/) (When you do a reset, you should see a sync pulse and a STSTB/)
2. If the CPU is running (the run light is on) but you don't get a sign on message the problem is more deeply rooted and an ICE80 will be needed to further troubleshoot the board. The first thing to check after connecting up the ICE80 is memory (both ROM and RAM)
- A. Hit the reset switch and read memory locations 00-FFF and E800H-EBFFF. These are the locations that the BOOT/DIAG. PROM practically occupies immediately following a reset. The first 3 locations should be C3 06 E8. Output a 00H to the CPU port (FFH) and the BOOT/DIAG PROM should disappear. Read memory locations F800H to F3FFF. This is the monitors area of memory and it is always present. (That is it doesn't disappear like the Boot Diag. PROM does. The first several locations should contain C3 XX F8.

If the data you get back from either the BOOT or MONITOR PROMS looks bad, check that you are getting CS on the appropriate PROM. (INH1/ and INH2/ should both be low when you have CS on the BOOT PROM, and only INH1/ will be low when you have CS on the MONITOR PROM.) Make sure you have command (MROC/) at pin 5 of A5. Also SEL ROM/ should be true when you either CS on the BOOT or MONITOR PROMS. SELROM/enables the LOCAL ACK timer, and enables the data bus driver A61. Are all addresses present at the ROM's. (One of the positive true address bus drivers A53 or A59 on sheet 8 could be bad. Be sure the FLOAT line is low, because this line is only used for testing the board on the terradyn and can have devastating effects if it is in the wrong state)

BOTH STARTUP/AND
SLL BOOT/TURNED OFF

CONDITION

TURN OFF STARTUP/

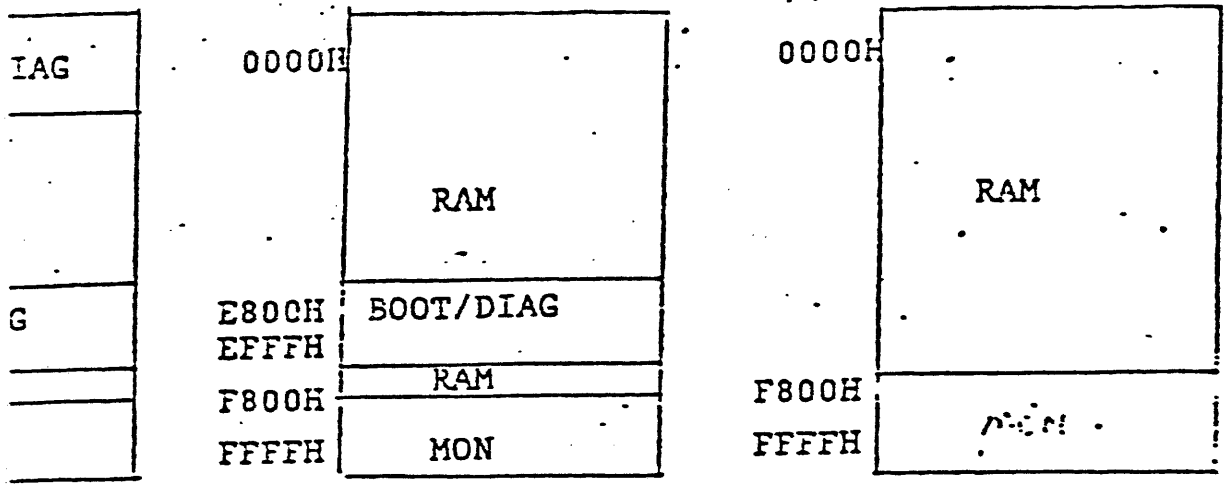

FIG. 1

- Scope A27 pin 19 (REFON/) and make sure REFRESH for the timing. This is a free running asynchronous signal that approximately every 15 usec and has a duration of 700 nsec. refresh, both banks at the same time, (RAS1/ and RAS2/ when come on).

following patterns into the following area to check all to and from RAM.

Ch 0 0FF = 2H
Ch 0 8FF = 4H

DATA	ADDRESS
00H	7FFFH
FFH	7FFFH
AAH	7FFFH
55H	7FFFH

addresses are good by writing on area of RAM with a pattern and then making sure you don't read that same back from any other area of RAM.

if these checks find a fault, there could be a deeply rooted one of the ram chips. (2116). The only way to really kind of a problem is with a Memory test (GALPAT) either in the MACRODATA, or through the BOOT/DIAG PROM position. can only be done if the IPD is functional except for a

If the CPU, RAM, and ROM are all OK, 90% of the board is functional and the rest of the system will be easier to troubleshoot.

The rest of this deals with areas of the board not directly related to the CPU, RAM, ROM section of the board.

INTERRUPTS

- A. Sheet 1 of the schematic deals specifically with the front panel panel interrupts.
1. If you depress one of the interrupt buttons and some of the other interrupt lights turn on the push button debounce circuitry is probably at fault.
 2. If you depress one of the buttons and interrupt gets serviced (the interrupt gets through to the 8080) but the light doesn't go off, you would suspect the AUTO acknowledge circuitry to be at fault. I

(Brief description of auto acknowledge circuitry) when the 8259 generates an INT to 8080 and interrupts are enabled, the 8228 (system controller) will release 3 separate INTA/ pulses to the 8259. The first INTA/ tells the 8259 to release into the data bus the CALL instruction (CDH). When the 8228 sees this CDH on the data bus it knows it has to release 2 more INTA's. The 2nd INTA/ from the 8228 tells the 8259 to release the low order byte of the branch address onto the bus and the 3rd INTA/ will cause the high order byte of the branch address to go out on the data bus.

When the 8080 sees all of this (CD XX XX) it will jump (VECT) to the appropriate point in memory.

During initialization of the 8259, it is programmed to sector in increments of 8 so that when the 8259 does a CALL to XX it will have the same effect as a RST instruction would.

The second byte released onto the bus is the critical one during the AUTO ACK. D3, D4, and D5 will look like the following at this point.

D5	D4	D3	INTERRUPT	
0	0	0	"	0
0	0	1	"	1
0	1	0	"	2
0	1	1	"	3
1	0	0	"	4
1	0	1	"	5
1	1	0	"	6
1	1	1	"	7

By looking at these three bits on the second INTA/, the AUTO ACK circuitry knows which interrupt the 8080 is servicing and the AUTO ACK circuitry can therefore reset the appropriate light.

BUS PRIORITY CIRCUITRY

Sheet 2 of the schematic deals primarily with the BUS arbitration logic. If the system gets the MONITOR'S sign on message but is not able to boot up ISIS from a controller plugged into the card cage, the problem could be in this area.

A92 and A93 comprise the BUS priority resolver network. Only one BPRN can be granted at a time. The BUS time OUT circuitry and the BUS clock logic are also shown on this sheet.

SERIAL CHANNELS

All logic for the 2 onboard serial channels is shown on sheets 4, 5, and 6 of the schematic. The 8253 shown on sheet 4 is a programmable counter that is used to generate the 2 different baud rates required to run the serial channels. Sheets 5 and 6 contain the serial channel #1 and Serial Channel # 2 USARTS and associated RS232 and current loop drives.

DECODER ROMS

There are four "Decoder Roms" used on the IPB. These devices are as PORT and FUNCTION selectors. A6, on sheet 7 of the schematic, controls the SEL ROM/. The 2 INHIBITS and Chip selecting the MON

signals on the input of the device as previously described.

A71 on the same page is strictly a port address decoder and will respond under the following addresses:

PORT ADDRESS	FUNCTION
C0-C3	SEL CRT/
C4-C5	SEL DPP/
F8-F9	SEL PIO/

ENABLE EXT/ is used to enable the data bus driver (A72 and A88) on sheet 6 and should be true for all addresses mentioned above.

A69 and A70 on sheet 5 are used in a similar manner.

PORT ADDRESS	FUNCTION
FF	SEL CPU/
FA-FB	SEL I2/
FC-FD	SEL I1/
F0-F7	SELWR/ (to read or write to) (the USARTS OR TIMER)

Output 4 of A69 enables the data lines to the USARTS, INTERVAL TIME and LOCAL INTERRUPT controller and is true for addresses F0-F7 and FA-FB.

Output 3 of A69 selects the data direction for the local data bus. This line should go true when you do an IORC/ to ports F0-F7 or FA-

These ROMS will not fail very often and should probably be one of the last things you check.

IOC CHECKOUT PROCEDURE

1. Put 3-Position Slide Switch in Upper Position (Diagnostic) and Apply Power.

Note: Switch must be in position before power is applied. For this first part, nothing else is needed (i.e., CRT, Keyboard, Floppy or IPB Board). The beeper should beep 5 times — if it does, go on to Step 2. Otherwise, do one of the following, depending on how many times the beeper beeped.

1.1 The beeper didn't beep at all, or beeps with a long continuous sound. This indicates a complete malfunction, and all of the following should be checked.

- That all socketable chips are inserted, that they are the correct chips, and that no pins have been bent.
- That all voltages are present — Particularly -5 volts, which is generated on the IOC board (VRI)
- That the two main clocks are present, 22.032 MHz, with $\phi 1$ and $\phi 2$ (sheet 2 of schematic) and 8 MHz (Y1, sheet 3)
- That the "RST" output of 8224 is low (sheet 2), and that the "master reset" is high (sheet 2).
- That pin 13 of A61 is low (sheet 5)
- That the "HRQ" output of 8257 (sheet 2) is not stuck high.
- That the "MEMR/" of 8228 is pulsing (sheet 2)
- That the jumpers in W11 are inserted correctly (sheet 11)
- That Pin 10 of the 8253 (sheet 1) is pulsing

That is the limit of the obvious malfunctions. Assuming that the beeper works (this can be checked by grounding $\phi AS3$ -PIN 3; See sheet 5), the problem is more subtle.

1.2 The beeper beeped once. This indicates that the problem is in the DMA area (8257, A58). Check the following:

- That A49 Pin 6 is pulsing (sheet 1)
- That "HRQ" output of 8257 is pulsing PIN 10
- That "DMACK" output of 8257 is pulsing PIN 25

As presently written, the diagnostic won't beep just 4 times — the fifth beep is free.

The beeper beeps five times. Kill power, attach a CRT and Keyboard, and reapply power (with switch still in upper position). A message should appear on screen. If not, check contrast pot and brightness pot, then proceed as in Section 1.4. If those signals are OK, problem is likely in logic shown on Sheet 10.

- Check 8 outputs of character generator PROM (A19).
- Check that A4.13 has pulses.
- Check that A5.6 has pulses.

If characters appear on screen, but they're garbled... check jumper W10 for 2708/2716.

- .0 The message appears legibly on screen. Hit the 4 keys as requested.
- .1 No response. Check that 3 KB outputs J1-9, J1-10, J1-11 are OK. "READ KE/" and "STATUS/DATA" should be pulsing. Verify that "KB RESET/" is not holding KB reset continually (sheet 5).
- .2 Incorrect response - this indicates that data lines are bad (shorted, crossed, whatever) from KB. The diagnostic should indicate which.
- .0 Correct Response From Keyboard - Put slide switch in local (bottom) pos: Turn power off and on again. A cursor will appear at upper left. Verify that all characters look good on screen, after entering them from KB.
- .0 To check out the remainder of the IOC board, it is necessary to hook up to an IPB.

- That "NLDA" output of 8080A-2 is pulsing PIN 21

Note: These should pulse once for each 15 μ s period, at this stage.

Note: Also check that A81 PIN 13 is low. If the switch is faulty, then the IOC board thinks it's in "online" mode, where it would beep once normally.

1.3 The beeper beeped twice. This indicates that the problem is in the RAM. Remove the 8080A-2 and insert ICE-80. Try to determine which RAM chips appear bad by using the ICE-80 "fill" command. You should attempt to fill RAM alternately with FF, 00, AA, 55. The RAM resides in address space 4000 to 5FFF.

'XF M 4 T 5 U' (to map RAM unguarded)

'FI M 4000H T 5FFFH = FFH' (or 00, 55H, AAH)

GF 0 UNT 13?? EXE TH DUMP

If just one RAM chip is bad, this will flag it for you. If all chips appear bad, then check that

- All RAM chips are of the same type (AbL or AbH, but not mixed)

- That jumper W9 is correctly configured for that type of chip

Otherwise, you'll have to scope it. Still using ICE-80,

'XF M 4 T 5 U'

'XF M 0 I 7'

'CH M 0 = 21H, 00H, 40H, 3EH, FFH, 77H, 7EH, C3H, 00H, 00H

'GO FR 0'

The statements above put a program into ICE which executes out of the MDS memory, but writes and reads from ICE RAM. The byte in address 04 (FF in the example above) should be whatever byte failed during the previous fill command.

With this program executing, sync on "MEMR/" (ASb.10, Sheet 8) and check all the RAM inputs during the write cycle - the 7 address inputs to RAMS should be high using the program given (sheet 9).

To get a clean trigger on "MEMR/" to check out the RAM chips during a read is a bit harder, because "MEMR/" pulses for other than RAM reads, too. However, you generally can tell if things are bad, even if non-RAM reads are mixed in. Check that Dout is the same as the previous Din - sometimes the outputs are marginal, not quite high enough for a plus.

1.4 The beeper beeped three times. This indicates something wrong in the CRT area. (sheet 10) check "vertical DRIVE/" and "Horizontal Drive" on CRT connector (PINS 9 and b, J15). Should be as follows:

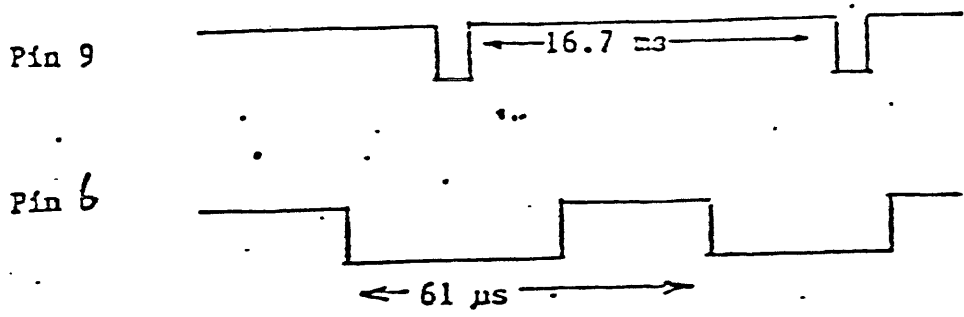

Check VRTC and HRTC on 8275. :Should be:

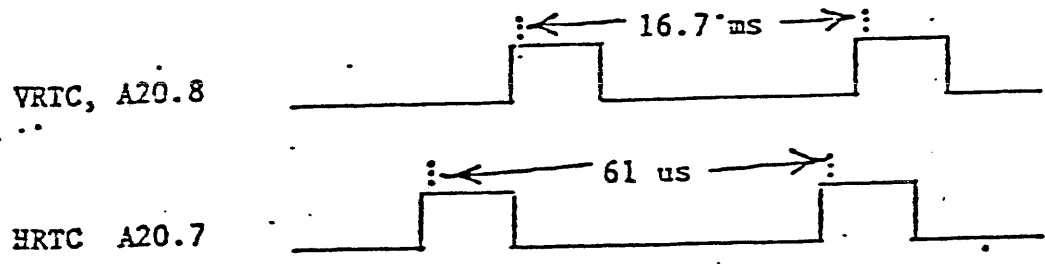

- Check "CCLK" input to 8275 : A20.30
- Check "DRQ" output : A20.5
- Check "DACK" input : A20.6

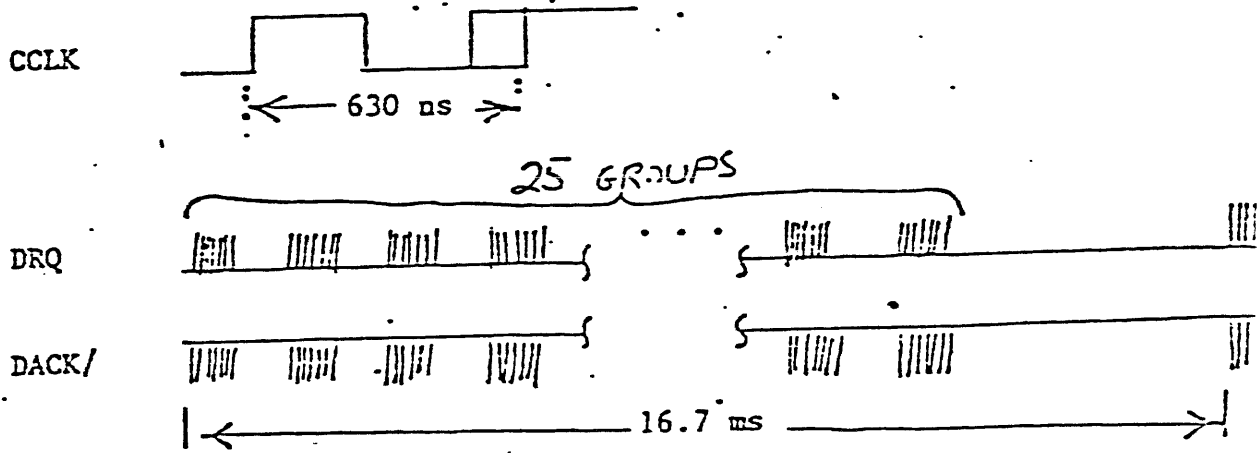

Note: If "DRQ" appears like;

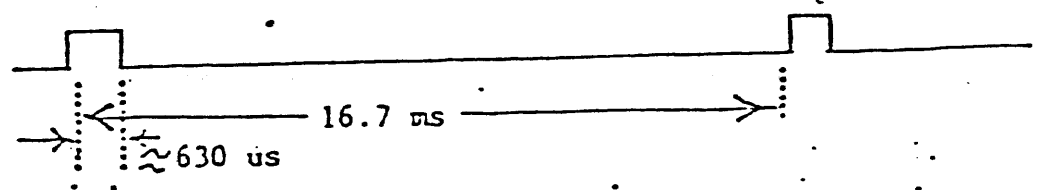

While DACK/ is always high, problem is in DMA chip (8257) area, not in 8275 area.

REWORK INSTRUCTIONS

REWORK NO. 5121REF ECO SEE BELOWSHEET 1 OF 3

SEE NOTE BELOW.

NUMBER 1001241-06 REV B PREP. BY: J. GARRISONDESCRIPTION PWA 1/0 CONTROLLER DATE: 4-6-79MDS 22X, 23X APPRO. BY: [Signature]

REV	PGS. AFFECTED	DATE
02	SHIT 8. REMOVE QC. STAMP	4-17-79

OR EFFECTIVITY

DESCRIPTION OF REWORK

- NOTE: A. THE FOLLOWING REWORK IDENTIFIES STEPS TO BE ACCOMPLISHED TO BRING THE 1001241 PWA 1/0 CONTROLLER UP TO -06 REV. B FROM DOWNREV. CONFIGURATIONS.
- B. ALL STEPS ARE SHOWN BEGINNING WITH 1001241-04 REV 12 AND ARE IN SEQUENCE.
- C. TO REWORK FROM A GIVEN CONFIGURATION, FIND THE PWA & PWB DASH NO. AND REV. LEVEL WHICH APPLY TO THAT SITUATION AND PROCEED FROM THAT POINT.
- D. ANY BOARD PRIOR TO 1001241-04 OR USING FAB BOARDS PRIOR TO 1001242-04 REV. 8, ARE TO BE SCRAPPED.

THE FOLLOWING ECO'S ARE REQUIRED:

ECO'S 1630, 1970, 1982, 2-2699A, 2-2408, 2-3774, 1747

- OBTAIN 1001241-04 REV. 18 DRAWING & PARTS LIST.
- INCORPORATE ECO'S 1630, 1970, 1982, 2-2699A, 2-2408 & 2-3774.
- PULL KIT TO 1001241-06 REV. B PARTS LIST.
- PERFORM NORMAL MASKING, STUFFING, ETC PER 1001241-06 REV B

REWORK INSTRUCTION: (CONT'D)

NOTE 1. A30 THRU A33 AND A41 THRU A44 MUST ALL BE IDENTICAL ON ANY PARTICULAR ASSEMBLY, EXCEPT 2108-A6L & 2109-4L OR 4ALL WHICH CAN BE MIXED.
 - IF THEY ARE ALL 52-111 (2108-A6L) AND 52-186 (2109-4L OR 2109-4A6L) -
 INSTALL W9 JUMPERS PER WIRE ROUTING LIST (PAGE 5 OF PARTS LIST.) -
 - IF THEY ARE ALL 52-110 (2108-A6H) AND 52-187 (2109-4H) INSTALL JUMPERS AS FOLLOWS: W9-C TO W9-D (REF. NOTE 4 ON FACE OF DWG.)
 W9-B TO W9-A

NOTE 2. R37 MUST BE LOADED PER SKETCH:
 PWB 1001242-04 REV. 8, 11, 12 OR 13.

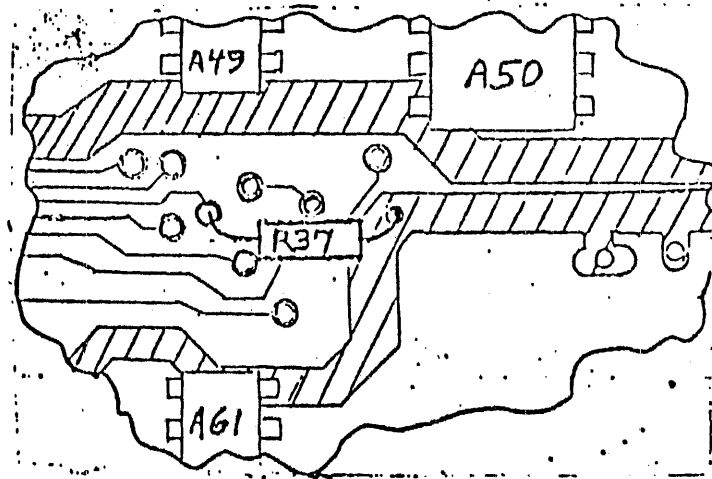

NOTE 3. C89 POLARITY MUST BE AS SHOWN ON SKETCH BELOW. STAMP OR MARK PWB AS SHOWN. PWB 1001242-04 REV 8 & 11.

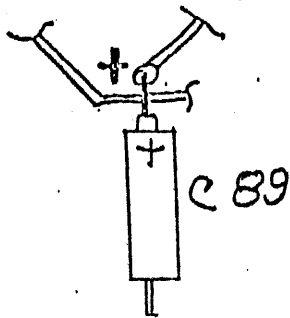

NOTE 4. ALL SECONDARY OPERATIONS TO BE DONE PER 1001241-06 REV B
 BELOW PWA NO. 1

WORK INSTRUCTION: (CONT'D)

ECO 1630 - PWA 101241-04 REV. 12 TO REV. 13, USING PWB 1001242-04 REV 8.

- STEP **1** CUT TRACE ABOVE FEEDTHRU BESIDE A25-4 (COMPONENT SIDE).
- STEP **2**, ADD JUMPER FROM A27-11 TO FEEDTHRU BESIDE A25-13 (COMP. SIDE),
RUNNING WIRE UNDER A24 & A25.

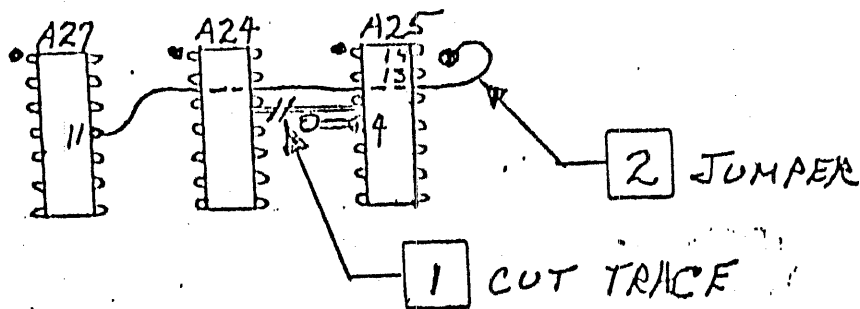

- STEP **3** MARK ECO 1630 ON SOLDER SIDE OF BOARD.

ECO 1970 PWA 1001241-04 REV. 18 TO REV. 19 USING PWB 1001242-04 REV. 08.
PARTS LIST CHANGE ONLY.

1. ITEM 105 WAS P/N 9100034 IS 9100123.

ECO 1982 PWA 1001241-04 REV 19 TO REV 20 USING PWB 1001242-04 REV. 08.
PARTS LIST CHANGE ONLY.

1. ITEM 16 WAS P/N 52-111 (C2108A6L) IS 52-186 (2109-4L 08 2109-4A6L)

WORK INSTRUCTION: (CONT'D)

0 2599A : PWA 1001241-04 REV 20 TO -05 REV 21, USING PWB 1001242-04 REV 8 OR 11.

PARTS LIST CHANGES:

- ITEM 2. WAS 2001243 SCHEMATIC IS 2002413 SCHEMATIC.
- ITEM 76. ADD C90 DESIGNATION CHG. QTY. WAS 44 IS 45.

REWORK INSTRUCTION:

- STEP 1 CUT TRACE (SOLDER SIDE) AT A49-8
- STEP 2 CUT TRACE (SOLDER SIDE) BETWEEN A17-3 AND A17-4.
- STEP 3 CUT TRACE (COMPONENT SIDE) A2-10 TO FEED THRU.
- STEP 4 CUT TRACE EMERGING FROM UNDER A34 (COMPONENT SIDE) BETWEEN PINS A34-11 AND A34-12.

SOLDER SIDE

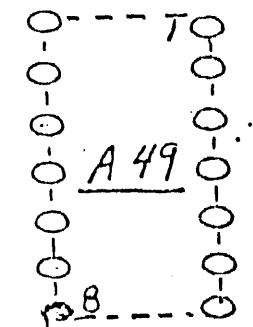

SOLDER SIDE

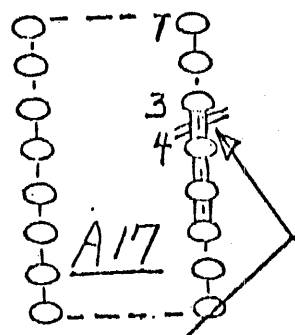

COMP. SIDE

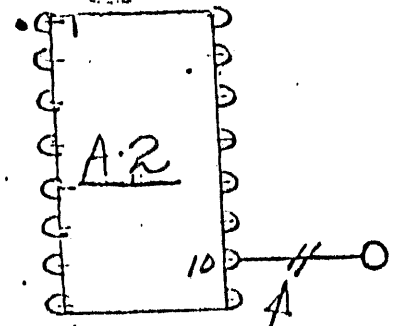

COMP. SIDE

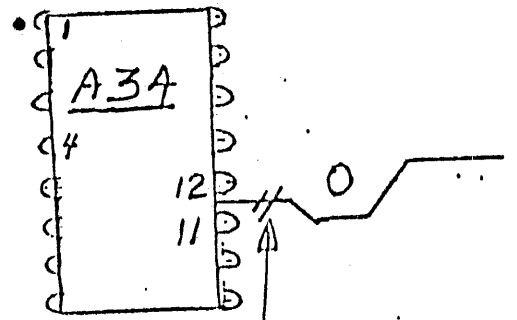

2 CUT TRACE BETWEEN

3 CUT TRACE A2-10 TO

4 CUT TRACE COMING OUT BETWEEN A34-11 & 12.

WORK INSTRUCTION: (CONT'D)

699A (CONT'D) PW13 1001242-04 REV. 8 & 11 ONLY

- STEP 5 ADD JUMPER FROM A49-10 TO A84-1. (COMPONENT SIDE).
- STEP 6 ADD JUMPER FROM A34-1 TO FEED THRU ADJACENT TO A36-5 (COMP. SIDE).
- STEP 7 ADD JUMPER FROM A17-1 TO A17-3 (COMPONENT SIDE).
- STEP 8 ADD JUMPER FROM FEEDTHRU ADJACENT TO A2-10 TO A2-12 (COMP. SIDE).
- STEP 9 ADD JUMPER FROM A6-11 TO J18-16 (SOLDER SIDE).
- STEP 10 ADD JUMPER FROM A6-12 & 13 TO A1-39 (SOLDER SIDE).

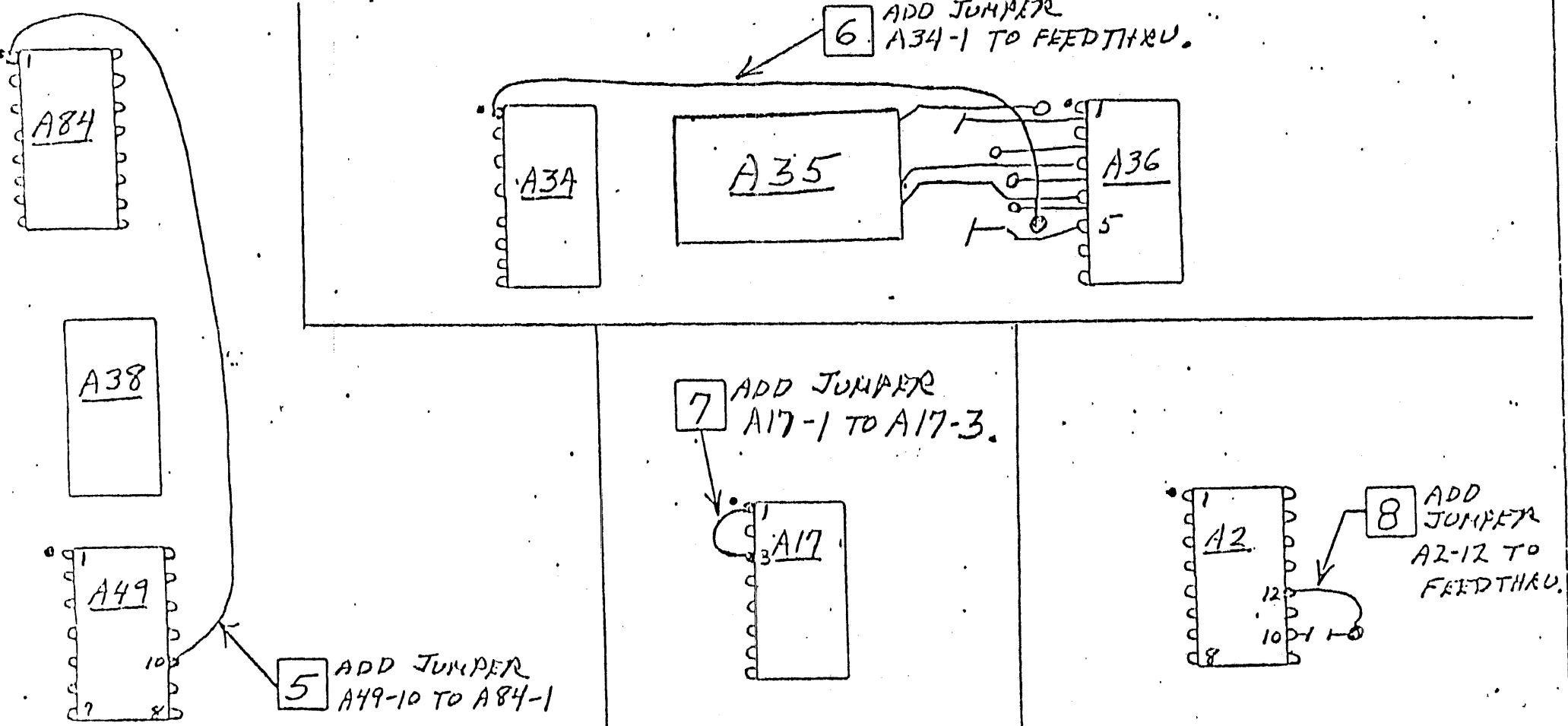

REWORK INSTRUCTION: (CONT'D)

2699A (CONT'D) PWB 1001242-04 REV. 8 & 11 ONLY.

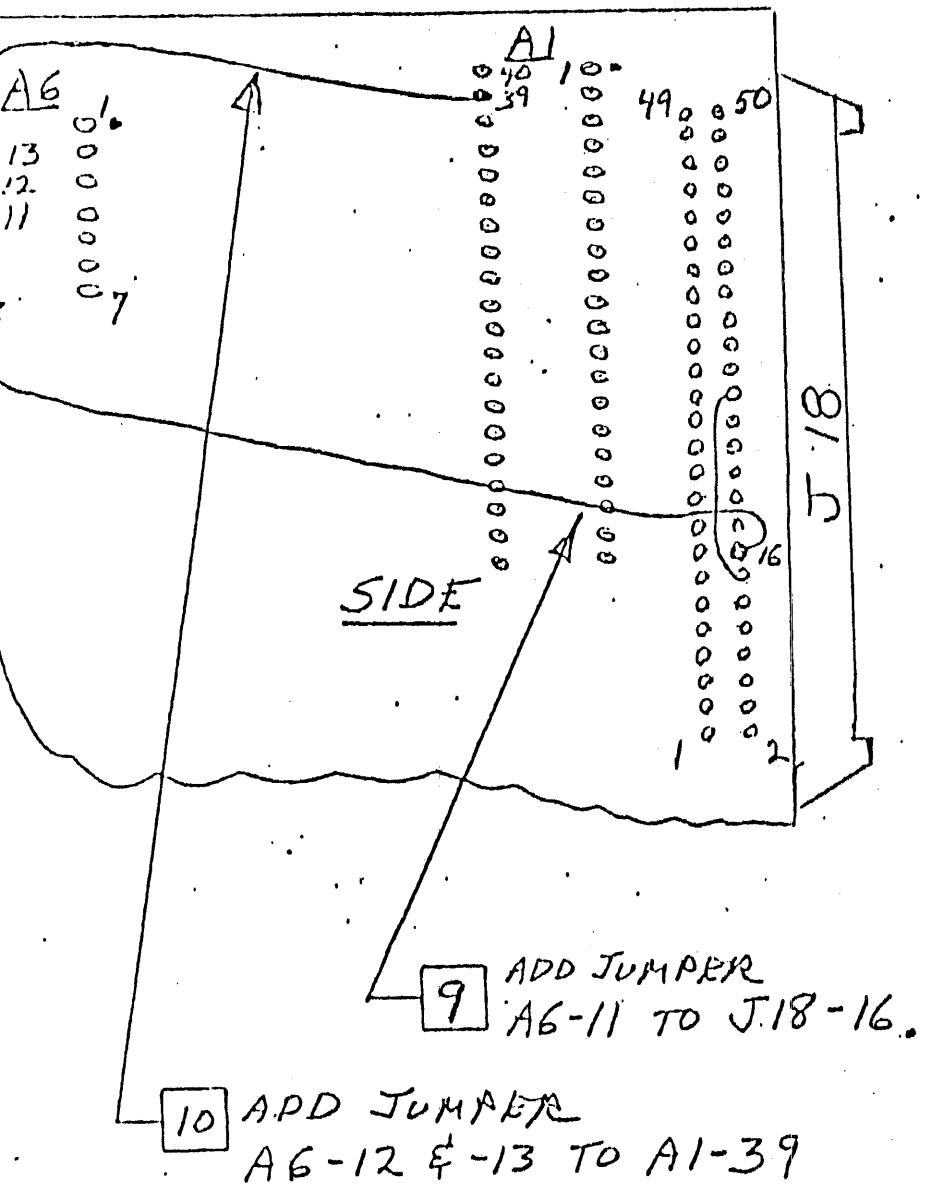

STEP 11 ADD (1EA) 470-Ω RESISTOR
P/N 56-019 FROM A68-6 TO
A68-16 (COMPONENT SIDE).

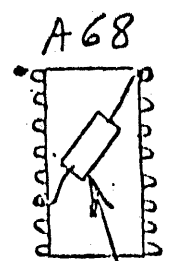

11 ADD 470 OHM RESISTOR
(56-019) A68-6 TO A68-16

REWORK INSTRUCTION: (CONT'D)

ECO 2699 A (CONT'D) NOTE: FOR 1001242-04 REV. 8, 11, 12 & 13.

STEP 12 ADD CAPACITOR C-90 IN PARALLEL TO RESISTOR R1.
P/N. 64-007 CAP. CER, .01UF $\pm 20\%$ 25V.

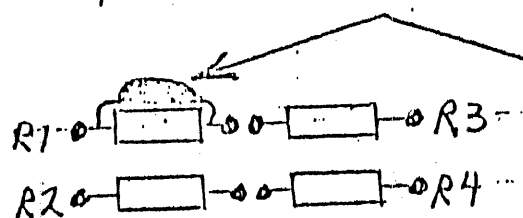

12 ADD CAPACITOR IN.
PARALLEL TO R1

COMPONENT SIDE

ECO 2-2408 PWA 1001041-05 REV 21 TO REV. A USING 1001242-04 REV 8, 11, 12, 13

PARTS LIST CHANGE ONLY

ITEM 6 WAS 52-016 IS 52-004.

ECO 2-3774 PWA 1001041-05 REV A TO -06 REV. B USING PWB 1001242-04 REV 8, 11, 12, 13

PARTS LIST CHANGE

ITEM 2 WAS 2002413 SCHEMATIC IS 2002583 SCHEMATIC

REWORK:

STEP 1 ADD JUMPER A72-7 TO A72-20 (SOLDER SIDE).

WORK INSTRUCTION: (CONT'D)

2-3774 (CONT'D).

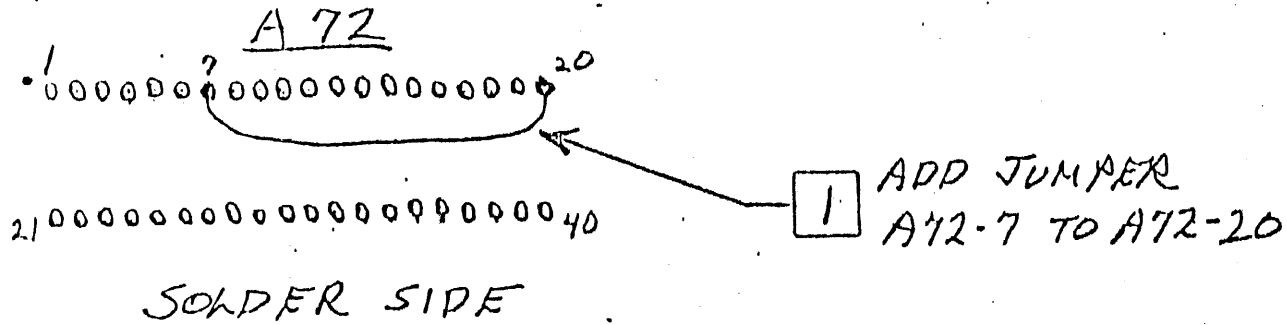
IDENTIFICATION !!IDENTIFY PWA (COMPONENT SIDE) AS 1001241-06 REV. B.STAMP ECO'S (SOLDER SIDE) AS FOLLOWS:

A. ALL PWA'S USING 1001242-04 REV. B PWB'S, STAMP WITH ECO Nos.
1630, 1970, 1982, 22699A, 2-2408, 2-3774, 1747.

B. ALL PWA'S USING 1001242-04 REV. 11 PWB'S, STAMP WITH ECO Nos.
2-2699A, 2-2408, 2-3774.

C. ALL PWA'S USING 1001242-04 REV. 12 OR REV. 13, STAMP WITH ECO Nos.
2-2699A, 2-2408, 2-3774.

NOTE: ALL REWORKED ASSYS. REQUIRE RETEST. REMOVE Q.C. STAMP PRIOR
TO SENDING TO TEST.

SEE NOTE BELOW.

NUMBER 1001241-06 REV B PREP. BY: J. GARRISONDESCRIPTION PWA 1/2 CONTROLLER DATE: 4-6-79MDS 22X, 23X APPRO. BY: [Signature]

REV	PGS. AFFECTED	DATE
02	SHIT 8. REMOVE QC. STAMP	4-17-79

EFFECTIVITY

DESCRIPTION OF REWORK

- NOTE: A. THE FOLLOWING REWORK IDENTIFIES STEPS TO BE ACCOMPLISHED TO BRING THE 1001241 PWA 1/2 CONTROLLER UP TO -06 REV. B FROM DOWNREV. CONFIGURATIONS.
- B. ALL STEPS ARE SHOWN BEGINNING WITH 1001241-04 REV 12 AND ARE IN SEQUENCE.
- C. TO REWORK FROM A. GIVEN CONFIGURATION, FIND THE PWA & PWB DASH NO. AND REV. LEVEL WHICH APPLY TO THAT SITUATION AND PROCEED FROM THAT POINT.
- D. ANY BOARD PRIOR TO 1001241-04 OR USING FAB BOARDS PRIOR TO 1001242-04 REV. 8. ARE TO BE SCRAPPED.

THE FOLLOWING ECO'S ARE REQUIRED:

ECO'S 1630, 1970, 1982, 2-2699A, 2-2408, 2-3774, 1747

- OBTAIN 1001241-04 REV. 18 DRAWING & PARTS LIST.
- INCORPORATE ECO'S 1630, 1970, 1982, 2-2699A, 2-2408 & 2-3774.
- PULL KIT TO 1001241-06 REV. B PARTS LIST.
- PERFORM NORMAL MASKING, STUFFING, ETC PER 1001241-06 REV B

REWORK INSTRUCTION: (CONT'D)

NOTE 1. A30 THRU A33 AND A41 THRU A44 MUST ALL BE IDENTICAL ON ANY PARTICULAR ASSEMBLY, EXCEPT 2108-A6L & 2109-4L OR -4A6L WHICH CAN BE MIXED.
 - IF THEY ARE ALL 52-111 (2108-A6L) AND 52-186 (2109-4L OR 2109-4A6L) -
 INSTALL W9 JUMPERS PER WIRE ROUTING LIST (PAGE 5 OF PARTS LIST.) -
 - IF THEY ARE ALL 52-110 (2108-A6H) AND 52-187 (2109-4H) INSTALL JUMPERS AS FOLLOWS: W9-C TO W9-D (REF. NOTE 4 ON FACE OF DWG.)
 W9-B TO W9-A

NOTE 2. R37 MUST BE LOADED PER SKETCH:
 PWB 1001242-04 REV. 8, 11, 12 OR 13.

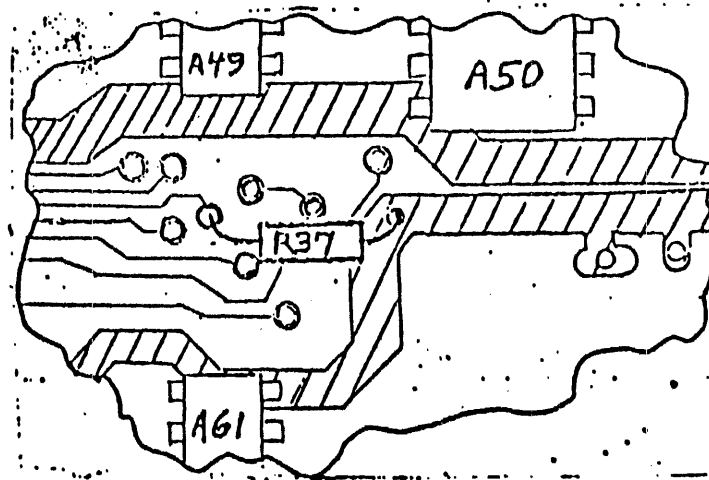

NOTE 3. C89 POLARITY MUST BE AS SHOWN ON SKETCH BELOW. STAMP OR MARK PWB AS SHOWN. PWB 1001242-04 REV 8 & 11.

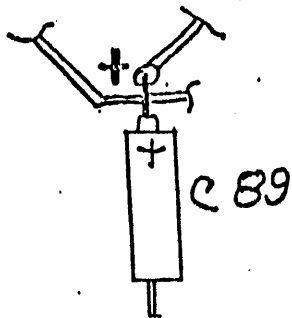

NOTE 4. ALL SECONDARY OPERATIONS TO BE DONE PER 1001241-06 REV B
 "RISK EPD 1487-2" BELOW PWA NO.

WORK INSTRUCTION: (CONT'D)

ECO 1630 - PWA 1001241-04 REV. 12 TO REV. 13, USING PWB 1001242-04 REV 8.

- STEP **1** CUT TRACE ABOVE FEEDTHRU BESIDE A25-4 (COMPONENT SIDE).
 STEP **2**, ADD JUMPER FROM A27-11 TO FEEDTHRU BESIDE A25-13 (COMP. SIDE),
 RUNNING WIRE UNDER A24 & A25.

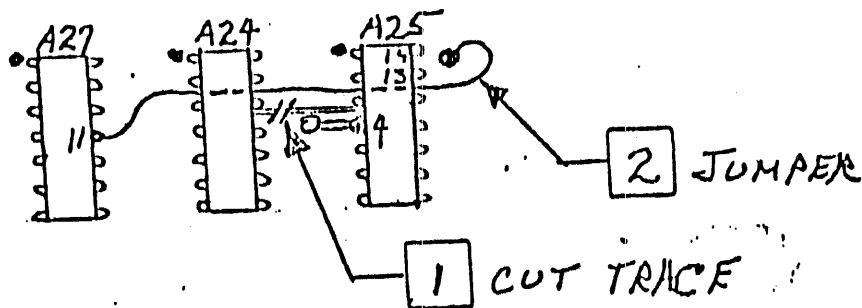

- STEP **3** MARK ECO 1630 ON SOLDER SIDE OF BOARD.

ECO 1970 PWA 1001241-04 REV. 18 TO REV. 19 USING PWB 1001242-04 REV. 08.
PARTS LIST CHANGE ONLY.

1. ITEM 105 WAS P/N 9100034 IS 9100123.

ECO 1982 PWA 1001241-04 REV 19 TO REV 20 USING PWB 1001242-04 REV. 08.
PARTS LIST CHANGE ONLY.

1. ITEM 16 WAS P/N 52-111 (C2108A6L) IS 52-186 (2109-4L OR 2109-4A6L)

REWORK INSTRUCTION: (CONT'D)

2699A : PWA 1001241-04 REV 20 TO -05 REV 21, USING PWB 1001242-04 REV 8 OR 11.

PARTS LIST CHANGES:

1. ITEM 2. WAS 2001243 SCHEMATIC IS 2002413 SCHEMATIC.
2. ITEM 76. ADD C90 DESIGNATION CHG. QTY. WAS 44 IS 45.

REWORK INSTRUCTION:

- STEP 1 CUT TRACE (SOLDER SIDE) AT A49-8
- STEP 2 CUT TRACE (SOLDER SIDE) BETWEEN A17-3 AND A17-4.
- STEP 3 CUT TRACE (COMPONENT SIDE) A2-10 TO FEED THRU.
- STEP 4 CUT TRACE EMERGING FROM UNDER A34 (COMPONENT SIDE) BETWEEN PINS A34-11 AND A34-12.

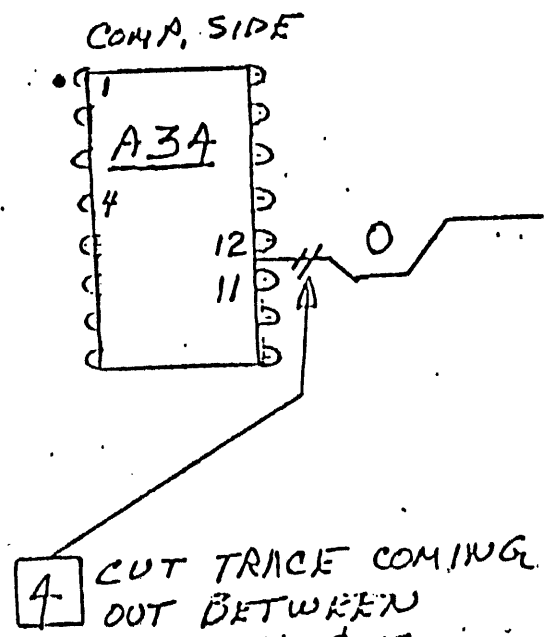
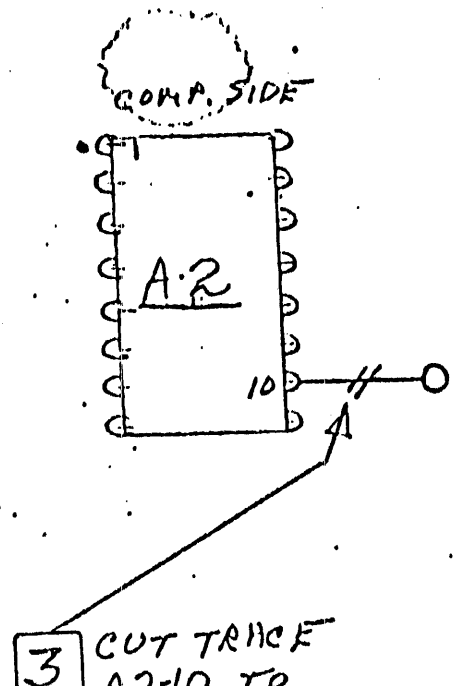
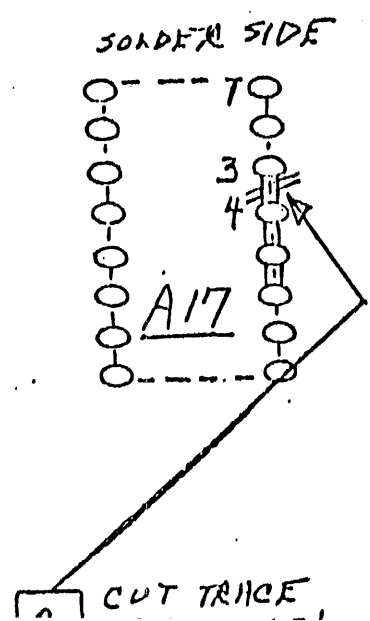
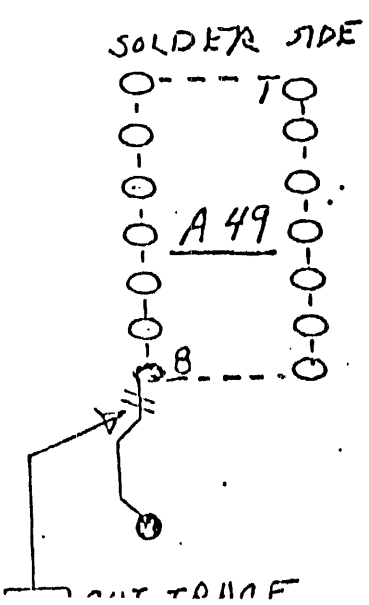

WORK INSTRUCTION: (CONT'D)

699A (CONT'D) PW13 1001242-04 REV. 8 & 11 ONLY

- STEP 5 ADD JUMPER FROM A49-10 TO A84-1. (COMPONENT SIDE).
- STEP 6 ADD JUMPER FROM A34-1 TO FEED THRU ADJACENT TO A36-5 (COMP. SIDE).
- STEP 7 ADD JUMPER FROM A17-1 TO A17-3 (COMPONENT SIDE).
- STEP 8 ADD JUMPER FROM FEEDTHRU ADJACENT TO A2-10 TO A2-12 (COMP. SIDE).
- STEP 9 ADD JUMPER FROM A6-11 TO J18-16 (SOLDER SIDE).
- STEP 10 ADD JUMPER FROM A6-12 & 13 TO A1-39 (SOLDER SIDE).

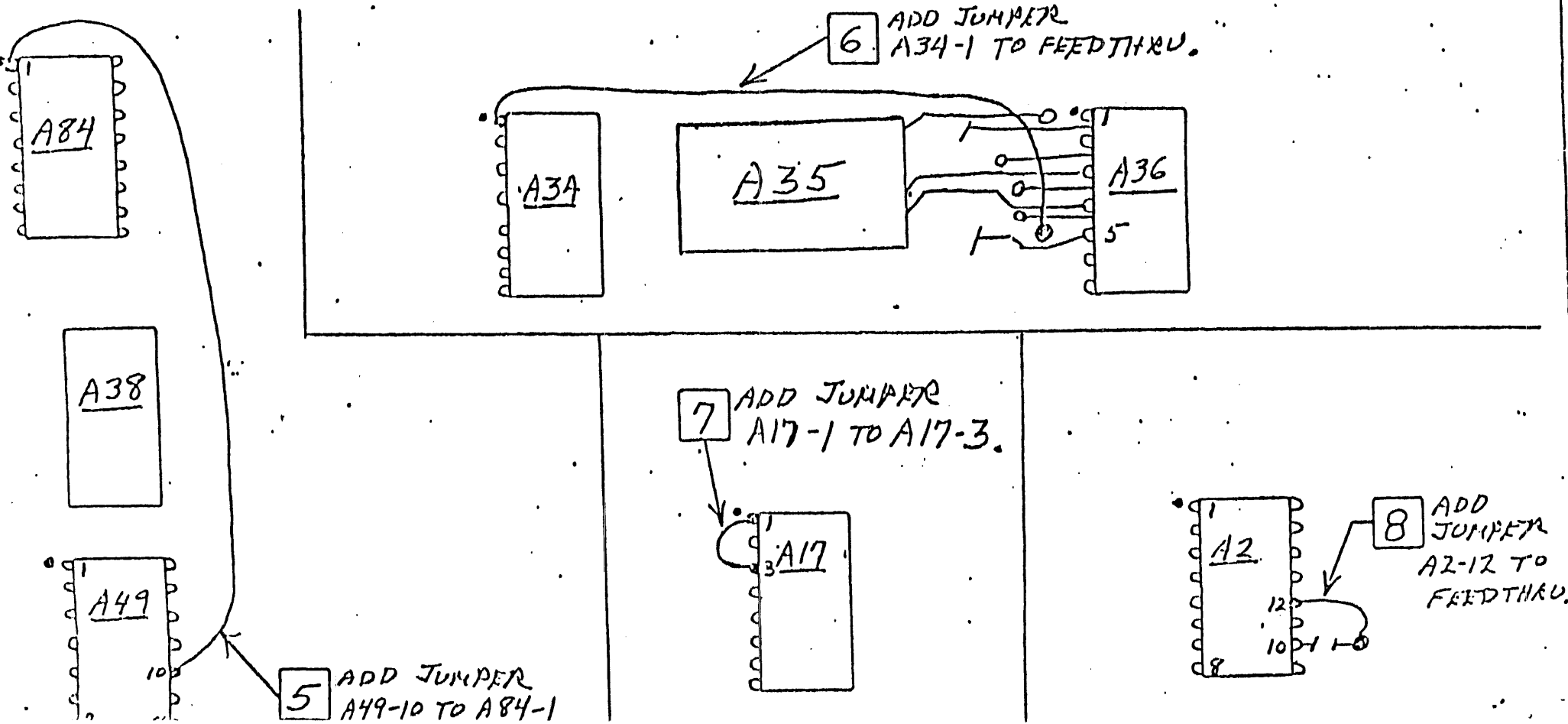

WORK INSTRUCTION: (CONT'D)

2699A (CONT'D) PWB 1001242-04 REV. 8 & 11 ONLY.

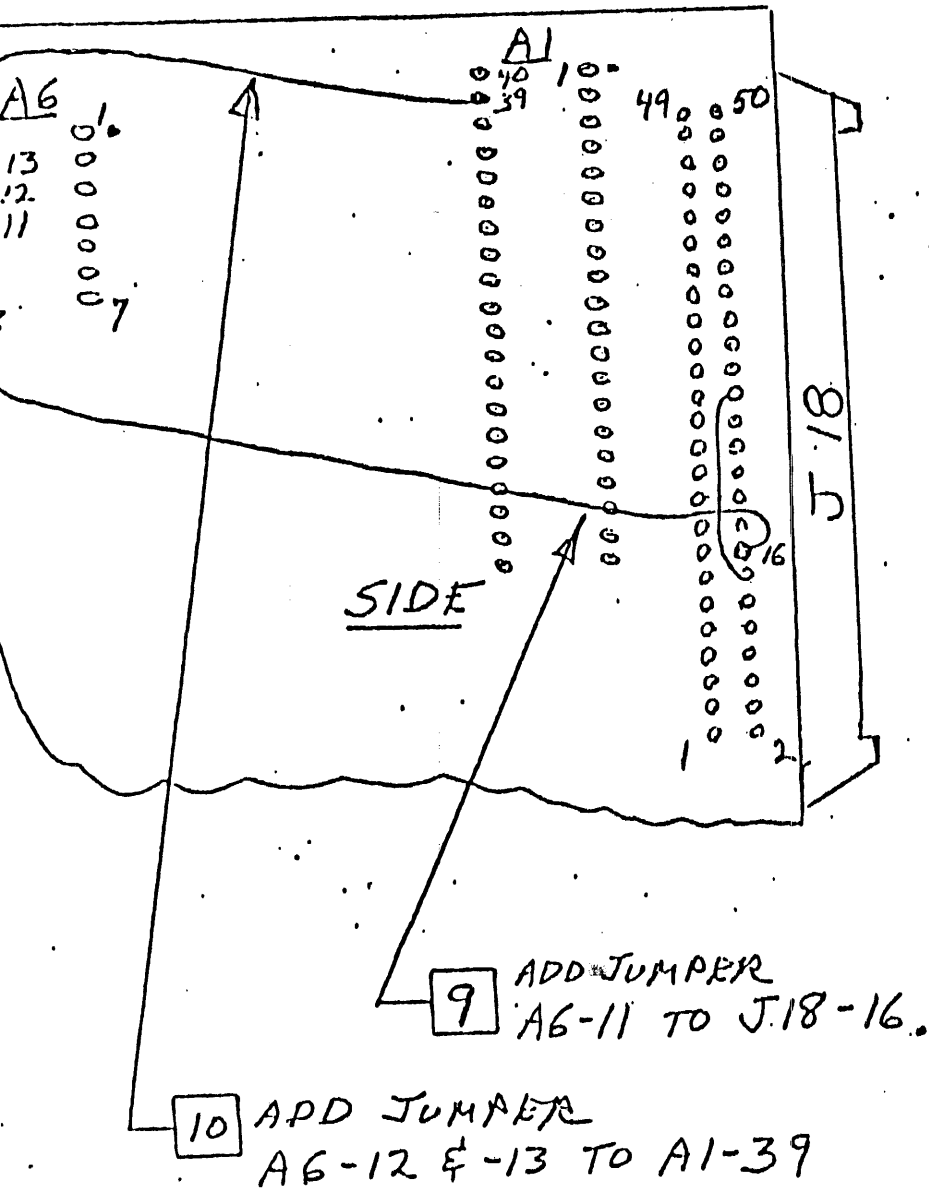

STEP

11 ADD (1EA) 470 Ω RESISTOR
P/N 56-019 FROM A68-6 TO
A68-16 (COMPONENT SIDE).

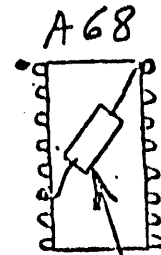

11 ADD 470 OHM RESISTOR
(56-019) A68-6 TO A68-16

REWORK INSTRUCTION: (CONT'D)ECO 2699 A (CONT'D) NOTE: FOR 1001242-04 REV. 8, 11, 12 & 13.

STEP 12 ADD CAPACITOR C-90 IN PARALLEL TO RESISTOR R1.
P/N. 64-007 CAP. CER, .01UF $\pm \frac{80}{20}\%$ 25V.

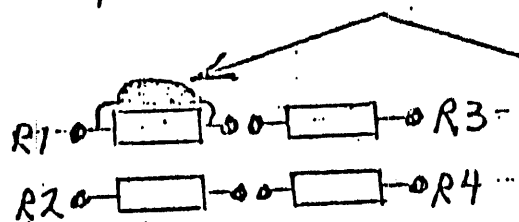

12 ADD CAPACITOR IN.
PARALLEL TO R1

COMPONENT SIDE

ECO 2-2408 PWA 1001041-05 REV 21 TO REV. A USING 1001242-04 REV 8, 11, 12,

PARTS LIST CHANGE ONLY

ITEM 6 WAS 52-016 IS 52-004.

ECO 2-3774 PWA 1001041-05 REV A TO -06 REV. B USING PWB 1001242-04 REV 8, 11, 12,

PARTS LIST CHANGE

ITEM 2 WAS 2002413 SCHEMATIC IS 2002583 SCHEMATIC

REWORK:

STEP 1 ADD JUMPER A72-7 TO A72-20 (SOLDER SIDE).

WORK INSTRUCTION: (CONT'D)

2-3774 (CONT'D).

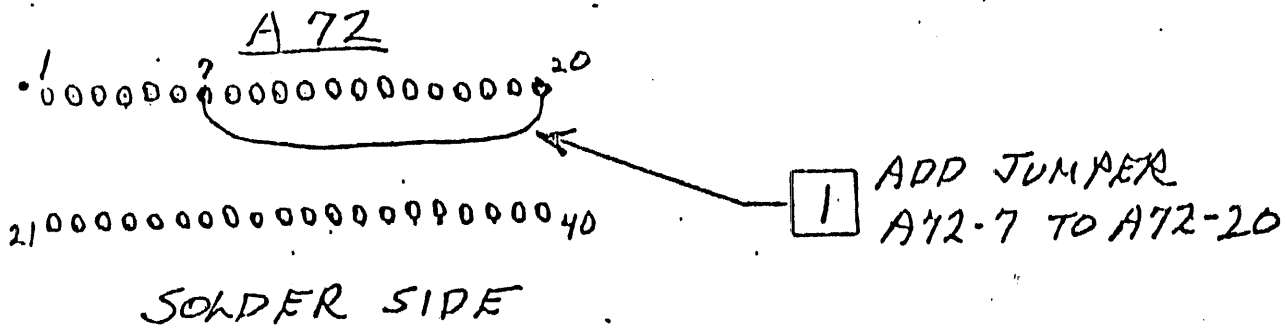
IDENTIFICATION !!IDENTIFY PWA (COMPONENT SIDE) AS 1001241-06 REV. B.STAMP ECO'S (SOLDER SIDE) AS FOLLOWS:

A. ALL PWA'S USING 1001242-04 REV. 8 PWB'S, STAMP WITH ECO Nos.
1630, 1970, 1982, 22699A, 2-2408, 2-3774, 1747.

B. ALL PWA'S USING 1001242-04 REV. 11 PWB'S, STAMP WITH ECO Nos.
2-2699A, 2-2408, 2-3774.

C. ALL PWA'S USING 1001242-04 REV. 12 OR REV. 13, STAMP WITH ECO Nos.
2-2699A, 2-2408, 2-3774.

NOTE: ALL REWORKED ASSYS. REQUIRE RETEST. REMOVE Q.C. STAMP PRIOR
TO SHIPPING TO TEST.

REWORK INSTRUCTIONS

REF ECO SEE BELOWSHEET 1 OF 8NUMBER SEE NOTE BELOW
1001241-06 REV B PREP. BY: J. GARRISONDESCRIPTION PWA YO CONTROLLER DATE: 4-6-79MDS 22X, 23X APPRO. BY: [Signature]

REV	PGS. AFFECTED	DATE
02	SHIT 8. REMOVE QC. STAMP	5/17/79

ON EFFECTIVITY

DESCRIPTION OF REWORK

- NOTE: A. THE FOLLOWING REWORK IDENTIFIES STEPS TO BE ACCOMPLISHED TO BRING THE 1001241 PWA YO CONTROLLER UP TO -06 REV. B FROM DOWNREV. CONFIGURATIONS.
- B. ALL STEPS ARE SHOWN BEGINNING WITH 1001241-04 REV 12 AND ARE IN SEQUENCE.
- C. TO REWORK FROM A GIVEN CONFIGURATION, FIND THE PWA & PWB DASH NO. AND REV. LEVEL WHICH APPLY TO THAT SITUATION AND PROCEED FROM THAT POINT.
- D. ANY BOARD PRIOR TO 1001241-04 OR USING FAB BOARDS PRIOR TO 1001242-04 REV. 8, ARE TO BE SCRAPPED.

THE FOLLOWING ECO'S ARE REQUIRED:

ECO'S 1630, 1970, 1982, 2-2699A, 2-2408, 2-3774, 1747

1. OBTAIN 1001241-04 REV. 18 DRAWING & PARTS LIST.
2. INCORPORATE ECO'S 1630, 1970, 1982, 2-2699A, 2-2408 & 2-3774.
3. PULL KIT TO 1001241-06 REV. B PARTS LIST.
4. PERFORM NORMAL MASKING, STUFFING, ETC PER 1001241-06 REV B.

REWORK INSTRUCTION: (CONT'D)

NOTE 1. A30 THRU A33 AND A41 THRU A44 MUST ALL BE IDENTICAL ON ANY PARTICULAR ASSEMBLY, EXCEPT 2108-A6L & 2109-4L OR-4ALL WHICH CAN BE MIXED.
 - IF THEY ARE ALL 52-111 (2108-A6L) AND 52-186 (2109-4L OR 2109-4A6L) INSTALL W9 JUMPERS PER WIRE ROUTING LIST (PAGE 5 OF PARTS LIST).
 - IF THEY ARE ALL 52-110 (2108-A6H) AND 52-187 (2109-4H) INSTALL JUMPERS AS FOLLOWS: W9-C TO W9-D (REF. NOTE 4 ON FACE OF DWG.)
 W9-B TO W9-A

NOTE 2. R37 MUST BE LOADED PER SKETCH:
 PWB 1001242-04 REV. 8, 11, 12 OR 13.

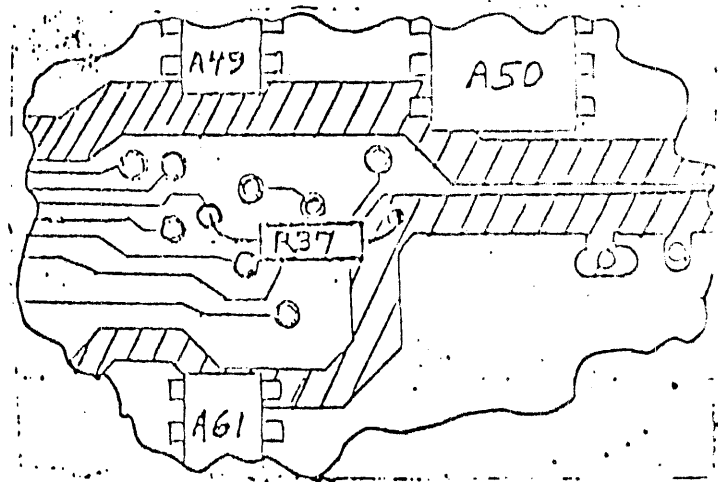

NOTE 3. C89 POLARITY MUST BE AS SHOWN ON SKETCH BELOW. STAMP OR MARK PWB AS SHOWN. PWB 1001242-04 REV 8 & 11.

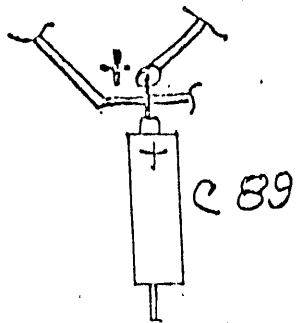

NOTE 4. ALL SECONDARY OPERATIONS TO BE DONE PER 1001241-06 REV B.
 BEFORE PWA NO. ON

WORK INSTRUCTION: (CONT'D)

ECO 1630 - PWA 101241-04 REV. 12 TO REV. 13, USING PWB 1001242-04 REV 8.

- STEP **1** CUT TRACE ABOVE FEEDTHRU BESIDE A25-4 (COMPONENT SIDE).
 STEP **2**, ADD JUMPER FROM A27-11 TO FEEDTHRU BESIDE A25-13 (COMP. SIDE),
 RUNNING WIRE UNDER A24 & A25.

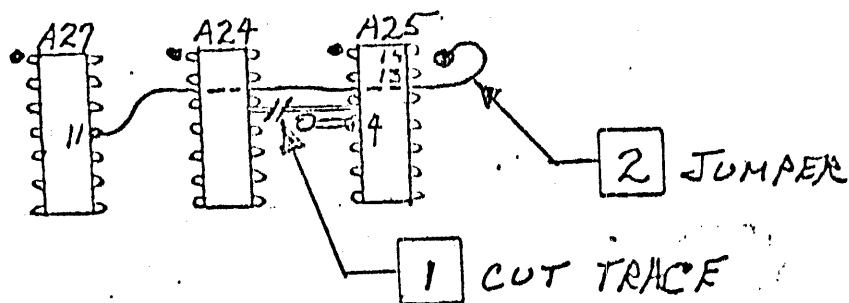

- STEP **3** MARK ECO 1630 ON SOLDER SIDE OF BOARD.

ECO 1970 PWA 1001241-04 REV. 18 TO REV. 19 USING PWB 1001242-04 REV. 08.

PARTS LIST CHANGE ONLY.

1. ITEM 105 WAS P/N 9100034 IS 9100123.

ECO 1982 PWA 1001241-04 REV 19 TO REV 20 USING PWB 1001242-04 REV. 08.

PARTS LIST CHANGE ONLY.

1. ITEM 16 WAS P/N 52-111 (C2108A6L) IS 52-186 (2109-4L 08 2109-4A6L)

REWORK INSTRUCTION: (CONT'D)

02699A : PWA 1001241-04 REV 20 TO -05 REV 21, USING PWB 1001242-04 REV 8 OR 11.

PARTS LIST CHANGES:

1. ITEM 2. WAS 2001243 SCHEMATIC IS 2002413 SCHEMATIC.
2. ITEM 76. ADD C90 DESIGNATION CHG. QTY. WAS 44 IS 45.

REWORK INSTRUCTION:

- STEP 1 CUT TRACE (SOLDER SIDE) AT A49-8
- STEP 2 CUT TRACE (SOLDER SIDE) BETWEEN A17-3 AND A17-4.
- STEP 3 CUT TRACE (COMPONENT SIDE) A2-10 TO FEED THRU.
- STEP 4 CUT TRACE EMERGING FROM UNDER A34 (COMPONENT SIDE) BETWEEN PINS A34-11 AND A34-12.

SOLDER SIDE

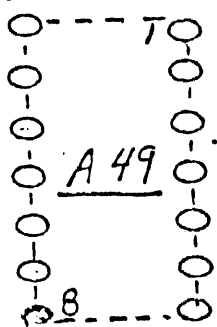

1 CUT TRACE AT A49-8

SOLDER SIDE

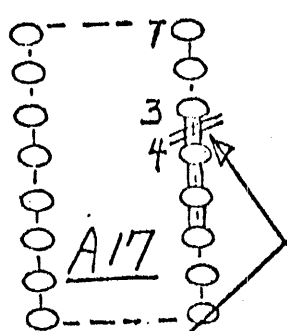

2 CUT TRACE BETWEEN A17-3 AND A17-4

COMP. SIDE

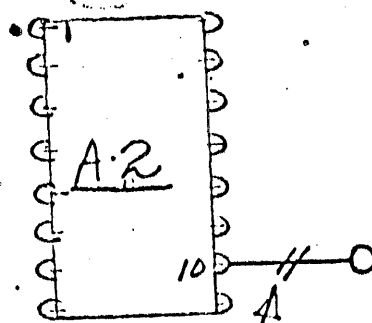

3 CUT TRACE A2-10 TO FEED THRU

COMP. SIDE

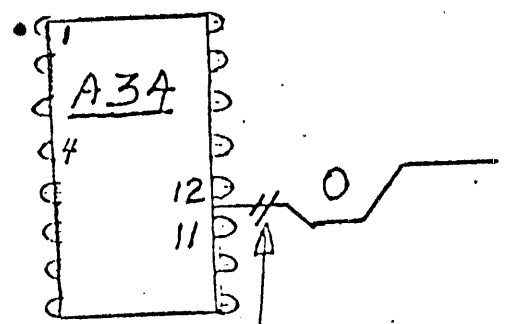

4 CUT TRACE COMING OUT BETWEEN A34-11 & 12.

WORK INSTRUCTION: (CONT'D)

2.699A (CONT'D) PW13 1001242-04 REV. 8 & 11 ONLY

- STEP 5 ADD JUMPER FROM A49-10 TO A84-1. (COMPONENT SIDE).
- STEP 6 ADD JUMPER FROM A34-1 TO FEED THRU ADJACENT TO A36-5 (COMP. SIDE).
- STEP 7 ADD JUMPER FROM A17-1 TO A17-3 (COMPONENT SIDE).
- STEP 8 ADD JUMPER FROM FEEDTHRU ADJACENT TO A2-10 TO A2-12 (COMP. SIDE).
- STEP 9 ADD JUMPER FROM A6-11 TO J18-16 (SOLDER SIDE).
- STEP 10 ADD JUMPER FROM A6-12 & 13 TO A1-39 (SOLDER SIDE).

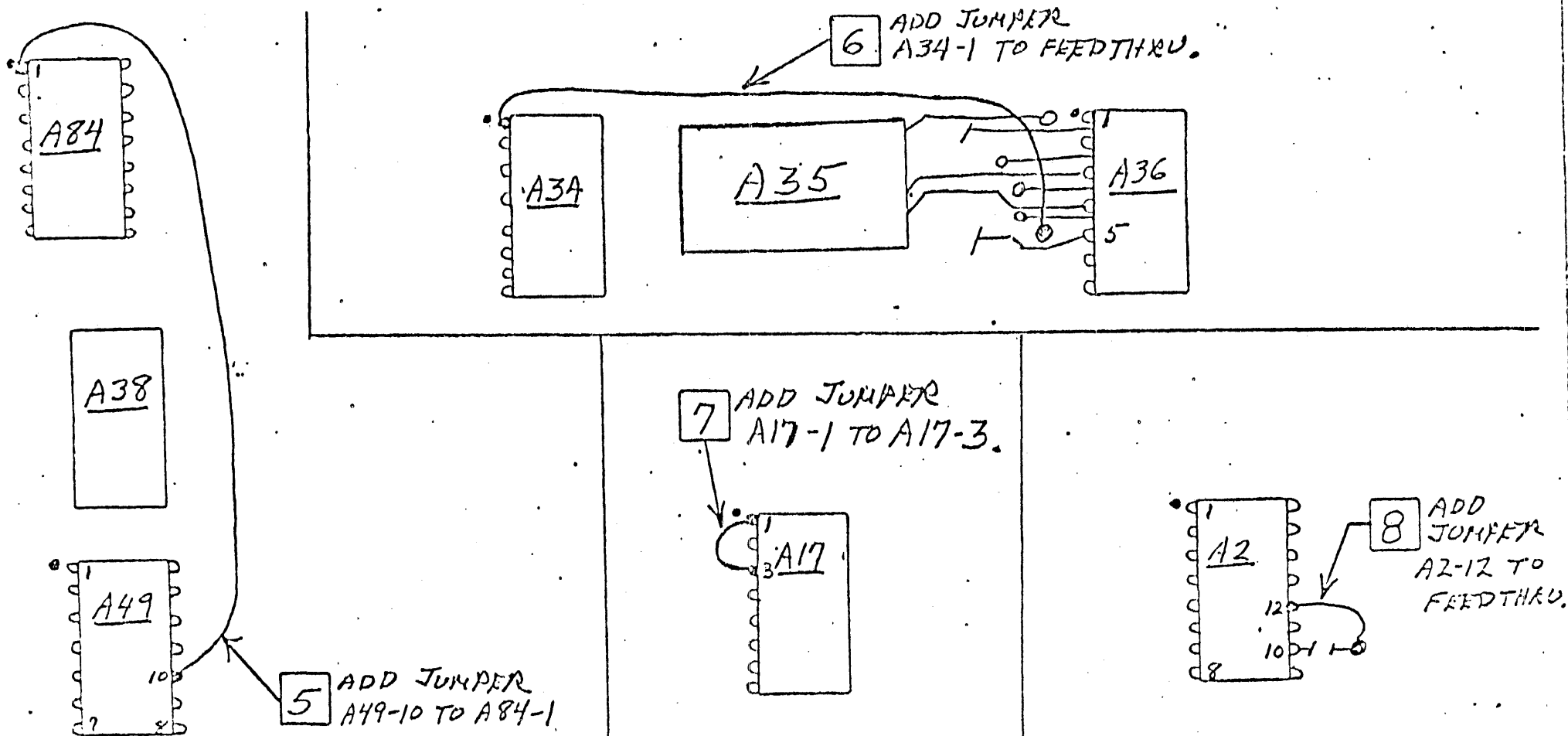

REWORK INSTRUCTION: (CONT'D)

2699A (CONT'D) PWB 1001242-04 REV. 8 & 11 ONLY.

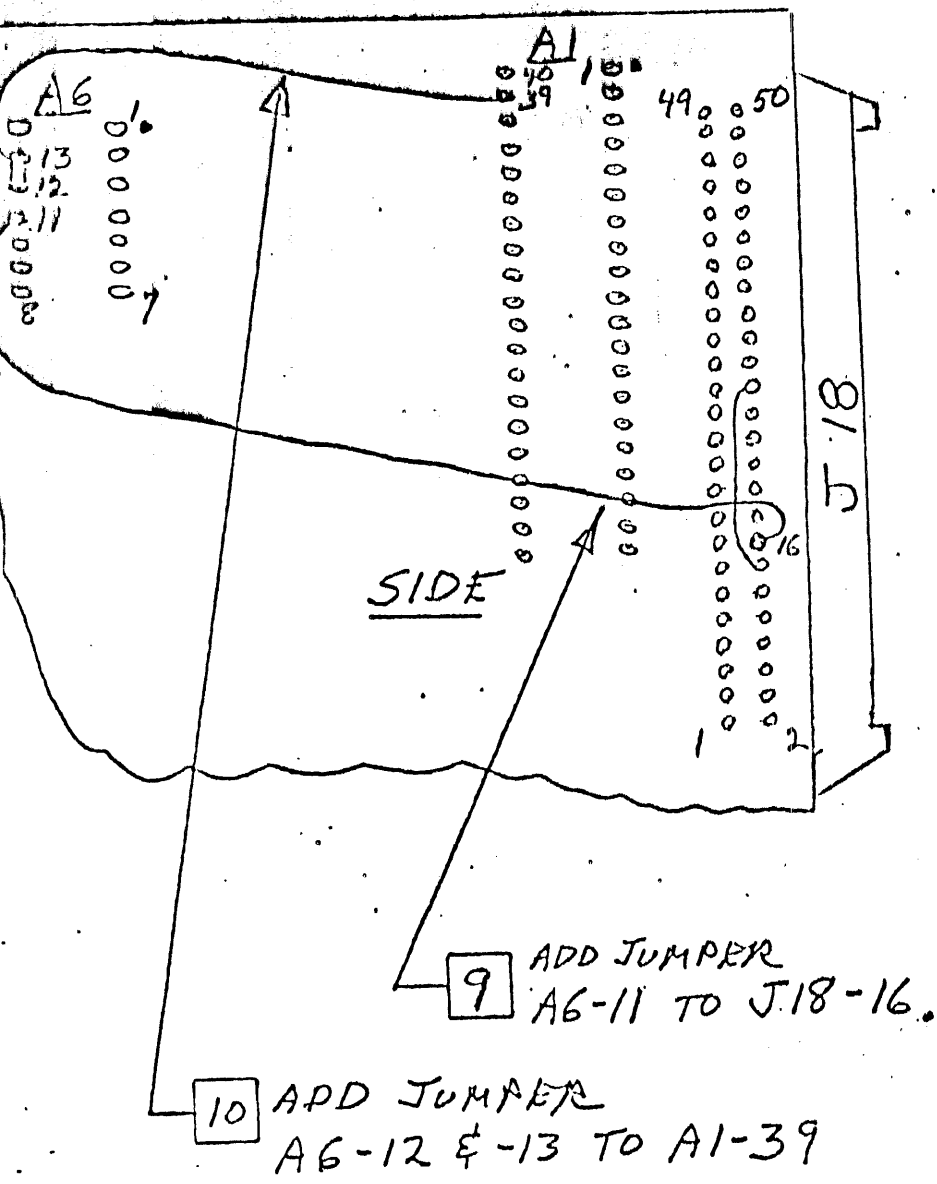

STEP 11 ADD (1EA) 470 Ω RESISTOR
P/N 56-019 FROM A68-6 TO
A68-16 (COMPONENT SIDE).

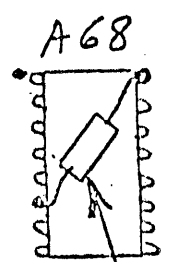

11 ADD 470 OHM RESISTOR
(56-019) A68-6 TO A68-16

REWORK INSTRUCTION: (CONT'D)

ECO 2699 A (CONT'D) NOTE: FOR 1001242-04 REV. 8, 11, 12 & 13.

STEP 12 ADD CAPACITOR C-90 IN PARALLEL TO RESISTOR R1.
P/N. 64-007 CAP. CER, .01UF $\pm 80\%$ 25V.

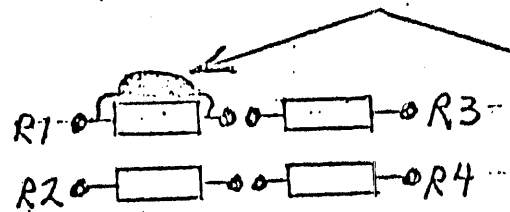

12 ADD CAPACITOR IN.
PARALLEL TO R1

COMPONENT SIDE

ECO 2-2408 PWA 1001041-05 REV 21 TO REV. A USING 1001242-04 REV 8, 11, 12, 13

PARTS LIST CHANGE ONLY

ITEM 6 WAS 52-016 IS 52-004.

ECO 2-3774 PWA 1001041-05 REV A TO -06 REV. B USING PWB 1001242-04 REV 8, 11, 12, 13

PARTS LIST CHANGE

ITEM 2 WAS 2002413 SCHEMATIC IS 2002583 SCHEMATIC

REWORK:

STEP 1 ADD JUMPER A72-7 TO A72-20 (SOLDER SIDE).

REWORK INSTRUCTION: (CONT'D)

2-3774 (CONT'D).

A72

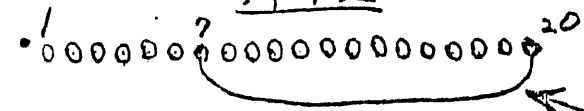

21 00000000000000000000000000000000 40

1

ADD JUMPER
A72-7 TO A72-20

SOLDER SIDE

IDENTIFICATION !!

IDENTIFY PWA (COMPONENT SIDE) AS 1001241-06 REV. B.

STAMP ECO'S (SOLDER SIDE) AS FOLLOWS:

A. ALL PWA'S USING 1001242-04 REV. B PWB'S, STAMP WITH ECO Nos.
1630, 1970, 1982, 22699A, 2-2408, 2-3774, 1747.

B. ALL PWA'S USING 1001242-04 REV. 11 PWB'S, STAMP WITH ECO Nos.
2-2699A, 2-2408, 2-3774.

C. ALL PWA'S USING 1001242-04 REV. 12 OR REV. 13, STAMP WITH ECO Nos.
2-2699A, 2-2408, 2-3774.

NOTE: ALL REWORKED ASSYS. REQUIRE RETEST. REMOVE Q.C. STAMP PRIOR
TO SHIPPING TO TEST.

1228 EXPANSION RACK/FRAME

1472 - WIRE ZIG ZAG/PLATE

1223 - 6 SLOT BACKPLANE

1240 - MICROPROCESSOR 3.58MHz crystal

{ 1271 - EXPANSION CHASSIS POWER SUPPLY
 " " " " " "
 2937 - XENON " "
 1255 - FLIGHT CRT " "

1166 - PIO

1203 - AUX PROM

1200 - CONTROL PANEL (7 SWITCH MAINFRAME (LED'S (INTE)
 TO GND 1 SWITCH MOMENTARY LED TO GND (RESET)

$R_{PI} (1K \pm 5\%)$ $R_I 240 \frac{1}{4}W \pm 5$
 15W

1241 - IOC

8253 (H) OPTIONAL FUSE VALUE

8257

PART 8212

CONTROL 8228

8080A-2

GEN 8224

FLOPPY 8271

8041

CRT 8275

8205 1 11

8220 1 11

3242

M 2108 (10) 1 11

M 2716 1 11 1 11

-0000 - 3FFF

JUMPER BC/DE W9

1196 IPB

8080A-2

GEN 8224 11

CNT 8228

PORT 8212

PIT 8253

HC 8259 11

BUS CONTROL 8218

USART 8251 11

8220 1 1 1 1

3601-1-1521 -1552
-1547 1522

8216 11

2716 11 Datasheet

2716 (16)

3242

3222 refresh

SYSTEM NOTES/CONNECTIONS

6

7 PARALLEL I/O
SERIAL TAPE READER J5 PUNCH J4
PROM PRGM J7
LINE PRINTER J6

8 RAM TIMING

9 RAM

10 CRT - 8275
CHAR GEN. (2708)

11 ROM (2716 x 4)

12 ROM (2716 x 4)

- 1 INTERRUPT PUSH-BUTTON DEBOUNCE (J1)
AUTO ACKNOWLEDGE TIMING
- 2 BUS PRIORITY ^{74148/74138} (P2 44-60) EQ-RN
SYS. CLOCKS ^{8224/77} BCX CCLK USART
BUS TIME OUT 100 μ sec.
- 3 CPU 8080A-2
8228
8224
- 4 BAUD RATE GEN. (8253)
INT. CONTROLLER (8259)
LOCAL ACK TIMER (177)
BUS CONTROLLER (8218)
- 5 SERIAL CHANNEL NO. 1 (8251)
(2x 8226)
(2x 3601)
- 6 SERIAL CHANNEL NO. 0 (8251)
LOCAL INT. CONTROL (8259)
(2x 8216)
OPTO ISOLATORS (3x TTL13)
- 7 MONITOR (2716)
BOOT (2716)
(2x 3601)
- 8 ADDR DECODE (3x LS240)

PWB 1001195-01 6106

IPB

PWA 1001194-

Hard wire

85P6 - 73P3

73P6 - 13P12

73P11 - 53P5

73P12 - to connect connector pins 22
but solder to the dot above A70P11

73P14 to the second dot above A88P16

AK-2 from A53P6 to A53P11 (45°)

A53P6 - A66P27

A55P11 has 330Ω to A55P14 (75°)

A55P12 to A55P13 to A13P11

A47P17 to A13P13

ALSO CUT REW FROM A47P17 TO
ON solder side

A52P11 to A41P11 -

A52P12 to A52P13 to A44P8

A44P9 to A27P19

A44P10 to A44P11 to A9P15

N solder side = A55P11 CPU PIN 14