



3601, 3621

256 x 4 HIGH SPEED RAM

3601-1, 3621-1	50 ns Max.
3601, 3621	70 ns Max.

- **Low Power Dissipation:**
0.5 mW/Bit Typical
- **Open Collector (3601) and Three-State Outputs (3621)**
- **Fast Programming:**
1 ms/Bit Typically
- **Polycrystalline Silicon Fuse**
- **16 Pin Dual In-Line Hermetic Package**

ROMs

The Intel® 3601/3621 is a 1024 bit PROM ideally suited for uses where fast turnaround and pattern experimentations are important, such as in prototypes or in small productions volume systems. The 3601 is manufactured with all outputs low, and logic high output levels can be electrically programmed in selected bit locations. The 3621 has its outputs initially high and logic low output levels are programmed. The same address inputs are used for both programming and reading.

A higher system performance is achieved by using the 3601-1 or 3621-1. These PROMs give a 25% system speed improvement over the 3601 or 3621.

The 3601/3621 is manufactured with the highly reliable polycrystalline silicon fuse and the fast switching Schottky barrier diode technology.

PIN CONFIGURATION

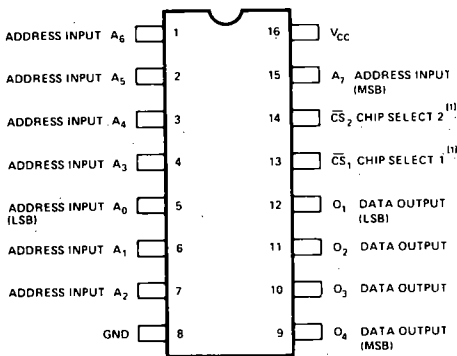

NOTE 1. DURING PROGRAMMING, THE PROGRAM PULSE MAY BE APPLIED TO EITHER CS₁ OR CS₂ FOR THE 3621 FAMILY. THE PROGRAM PULSE IS APPLIED TO CS₂ FOR THE 3601 FAMILY.

LOGIC SYMBOL

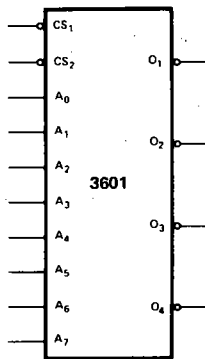

LOGIC SYMBOL

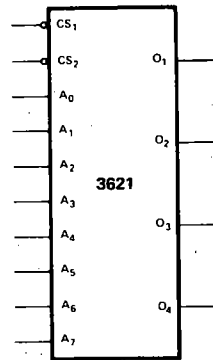

PIN NAMES

A ₀ -A ₇	ADDRESS INPUTS
CS ₁ -CS ₂	CHIP SELECT INPUTS
O ₁ -O ₄	DATA OUTPUTS

Absolute Maximum Ratings*

Temperature Under Bias	-65°C to +125°C	
Storage Temperature	-65°C to +160°C	
Output or Supply Voltages	-0.5V to 7 Volts	
All Input Voltages	-1.6V to 5.5V	
Output Currents	100mA	
Programming Only:		
	3601	3621
Output or V _{CC} Voltages	10.25V	13V
CS ₂ Voltage	15.5V	15.5V
CS ₂ Current	100mA	150mA
V _{CC} Current	500mA	600mA

*COMMENT

Stresses above those listed under "Absolute Maximum Rating" may cause permanent damage to the device. This is a stress rating only and functional operation of the device at these or at any other condition above those indicated in the operational sections of this specification is not implied.

D. C. Characteristics: All Limits Apply for V_{CC} = +5.0V ±5%, T_A = 0°C to +75°C Unless Otherwise Specified.

Symbol	Parameter	Limits			Unit	Test Conditions
		Min.	Typ. ^[1]	Max.		
I _{FA}	Address Input Load Current		-0.05	-0.25	mA	V _{CC} = 5.25V, V _A = 0.45V
I _{FS}	Chip Select Input Load Current		-0.05	-0.25	mA	V _{CC} = 5.25V, V _S = 0.45V
I _{RA}	Address Input Leakage Current			40	μA	V _{CC} = 5.25V, V _A = 5.25V
I _{RS}	Chip Select Input Leakage Current			40	μA	V _{CC} = 5.25V, V _S = 5.25V
V _{CA}	Address Input Clamp Voltage		-0.9	-1.5	V	V _{CC} = 4.75V, I _A = -10mA
V _{CS}	Chip Select Input Clamp Voltage		-0.9	-1.5	V	V _{CC} = 4.75V, I _S = -10mA
V _{OL}	Output Low Voltage		0.3	0.45	V	V _{CC} = 4.75V, I _{OL} = 15mA
I _{CC}	Power Supply Current		90	130	mA	V _{CC} = 5.25V, V _{A0} → V _{A7} = 0V CS ₁ = CS ₂ = 0V
V _{IL}	Input "Low" Voltage			0.85	V	V _{CC} = 5.0V
V _{IH}	Input "High" Voltage	2.0			V	V _{CC} = 5.0V

FOR 3621, 3621-1 ONLY

Symbol	Parameter	Limits			Unit	Test Conditions
		Min.	Typ. ^[1]	Max.		
I _O	Output Leakage for High Impedance Stage			40	μA	V _O = 5.25V or 0.45V, V _{CC} = 5.25V, CS ₁ = CS ₂ = 2.4V
I _{SC} ^[2]	Output Short Circuit Current			-60	mA	V _{CC} = 5.00V, T _A = 25°C, V _O = 0V
V _{OH}	Output High Voltage	2.4			V	I _{OH} = -2.4mA, V _{CC} = 4.75V

- NOTES: 1. Typical values are at 25°C and at nominal voltage.
2. Unmeasured outputs are open during this test.

A. C. Characteristics $V_{CC} = +5V \pm 5\%$, $T_A = 0^\circ C$ to $+75^\circ C$

SYMBOL	PARAMETER	MAXIMUM LIMITS			UNIT	CONDITIONS
		0°C	25°C	75°C		
t_{A++} , t_{A--} t_{A+-} , t_{A-+}	3601-1 and 3621-1 Address to Output Delay	50	50	50	ns	Both C.S. lines must be at ground potential to activate the PROM.
t_{A++} , t_{A--} t_{A+-} , t_{A-+}	3601 and 3621 Address to Output Delay	70	60	70	ns	
t_{S++} , t_{S--}	Chip Select to Output Delay	25	25	25	ns	

Capacitance ⁽¹⁾ $T_A = 25^\circ C$

SYMBOL	PARAMETER	LIMITS		UNIT	TEST CONDITIONS
		TYP.	MAX.		
C_{INA}	Address Input Capacitance	4	10	pF	$V_{CC} = 5V$ $V_{IN} = 2.5V$
C_{INS}	Chip-Select Input Capacitance	6	10	pF	$V_{CC} = 5V$ $V_{IN} = 2.5V$
C_{OUT}	Output Capacitance	7	12	pF	$V_{CC} = 5V$ $V_{OUT} = 2.5V$

NOTE 1: This parameter is only periodically sampled and is not 100% tested.

Switching Characteristics

Conditions of Test:
 Input pulse amplitudes - 2.5V
 Input pulse rise and fall times of 5 nanoseconds between 1 volt and 2 volts
 Speed measurements are made at 1.5 volt levels
 Output loading is 15 mA and 30 pF
 Frequency of test - 2.5 MHz

15 mA TEST LOAD

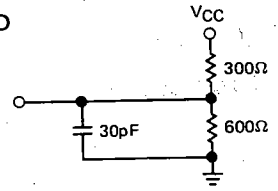

Waveforms

ADDRESS TO OUTPUT DELAY

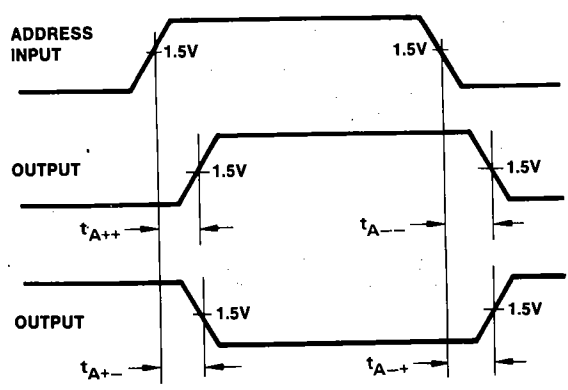

CHIP SELECT TO OUTPUT DELAY

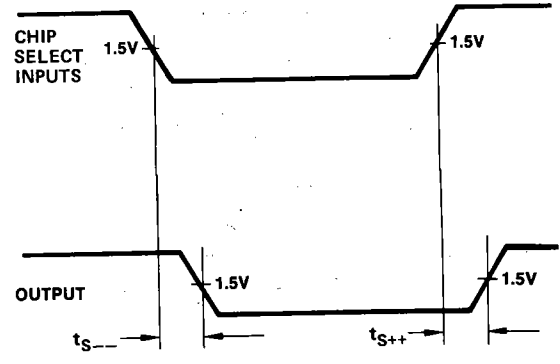

Typical D. C. Characteristics

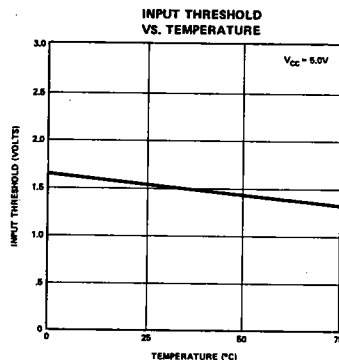
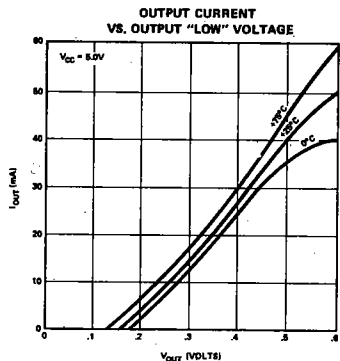
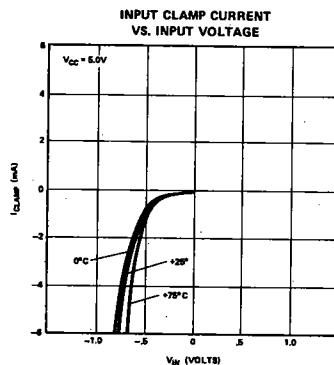
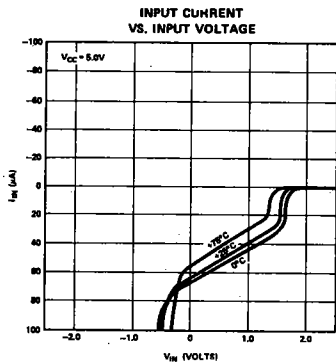

Typical A. C. Characteristics

